

PULSED POWER SYSTEM

脈衝功率系統



Po-Yu Chang

Institute of Space and Plasma Sciences, National Cheng Kung University

2023 Fall Semester

Tuesday 9:10-12:00

Lecture 3

<http://capst.ncku.edu.tw/PGS/index.php/teaching/>

Online courses:

<https://nckucc.webex.com/nckucc/j.php?MTID=md577c3633c5970f80cbc9e821927e016>

Reference



- **Foundations of pulsed power technology, by Jane Lehr & Pralhad Ron**
- **Pulsed power systems, by H. Bluhm**
- **Pulsed power, by Gennady A. Mesyats**
- **J. C. Martin on pulsed power, edited by T. H. Martin, A. H. Guenther, and M. Kristiansen**
- **Pulse power formulary, by Richard J. Adler**

- **Circuit analysis, by Cunningham and Stuller**

Outlines



- Introduction to pulsed-power system
- Review of circuit analysis
- **Static and dynamic breakdown strength of dielectric materials**
 - **Gas – Townsend discharge (avalanche breakdown), Paschen's curve**
 - **Liquid**
 - **Solid**
- Energy storage
 - Pulse discharge capacitors
 - Marx generators
 - Inductive energy storage

Dielectric materials



- Dielectric substances serve both as “insulators” in generator components such as capacitors, high-voltage (HV) transmission lines, and as “working media” in switches.

- Capacitor



$$E = \frac{1}{2} CV^2$$

- Transmission line



- HV switch

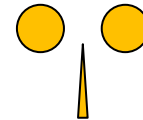

- The properties of these devices are strongly depend on
 - Electric breakdown strength / dielectric strength.
 - Dielectric constant.
- The dielectric strength of an insulant can be defined as “the maximum field stress that the material can withstand for a given time.”

Electric strength also depends on the sample geometry, pressure, temperature, and electrode material.



- **Geometry**

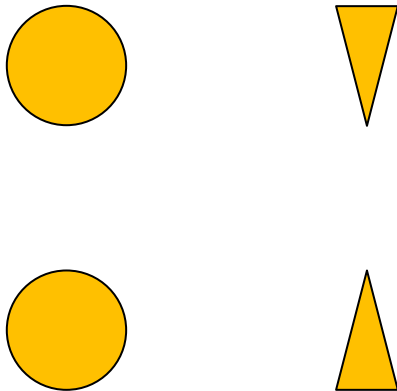

- **Pressure/temperature**

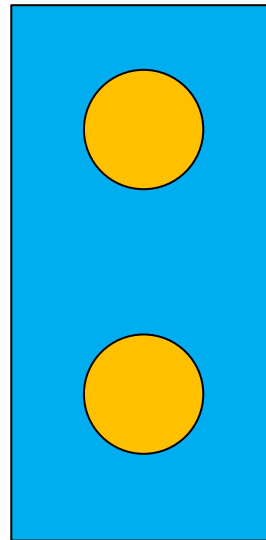

Pressurized/vacuum

- **Electrode material**

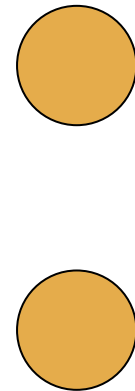

Copper/Tungsten

Collisions play an important role in ionization process



- At the microscopic level, breakdown requires the presence of sufficiently energy charge particles that have acquired enough energy from the applied electric field between two energy-dissipating collisions to ionize the material and to create more charge particles.

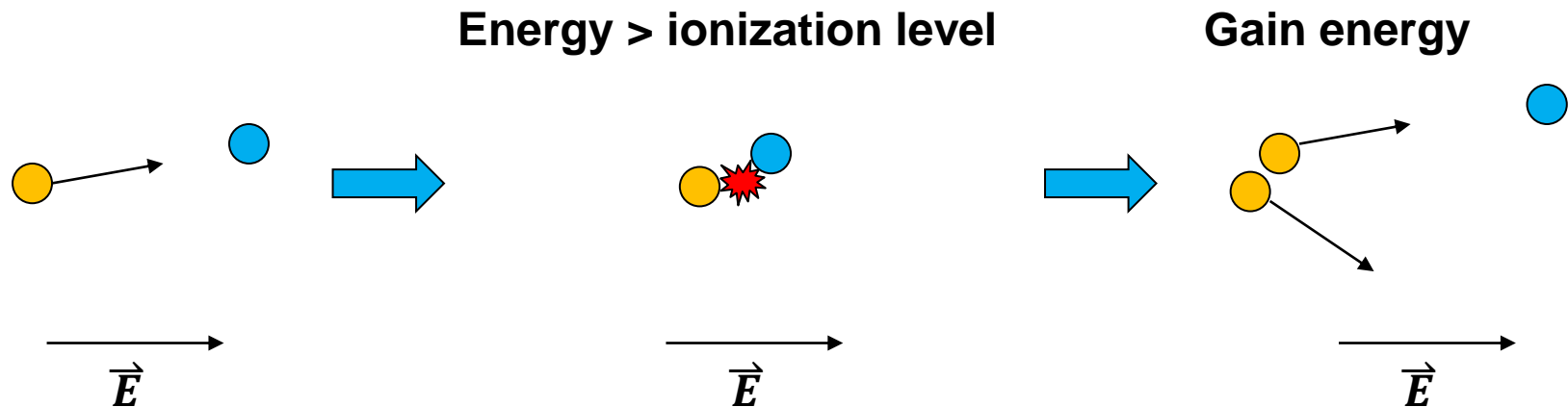

Mean free path is important in ionization process



- In order for an electron to acquire enough energy between collisions, its mean free path in the material must be sufficient enough.

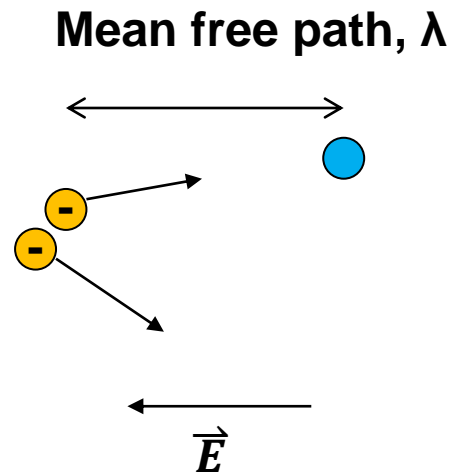

$$E_k = e \times E \times \lambda = eV$$

Outlines



- Introduction to pulsed-power system
- Review of circuit analysis
- **Static and dynamic breakdown strength of dielectric materials**
 - **Gas – Townsend discharge (avalanche breakdown), Paschen's curve**
 - Liquid
 - Solid
- Energy storage
 - Pulse discharge capacitors
 - Marx generators
 - Inductive energy storage

Kinetic energy needs to be greater than the ionization energy to ionize the gas



- Between each collision, the kinetic energy increases.

$$\lambda eE = \frac{1}{2} m v^2 \quad v = \sqrt{\frac{2eE\lambda}{m}}$$

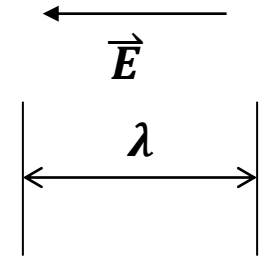

- Mean time between ionization collisions for electron with velocity v :

$$\tau = \frac{\lambda}{v}$$

- The rate of ionization is:

$$\frac{1}{\tau} = \frac{v}{\lambda} = \Sigma v$$

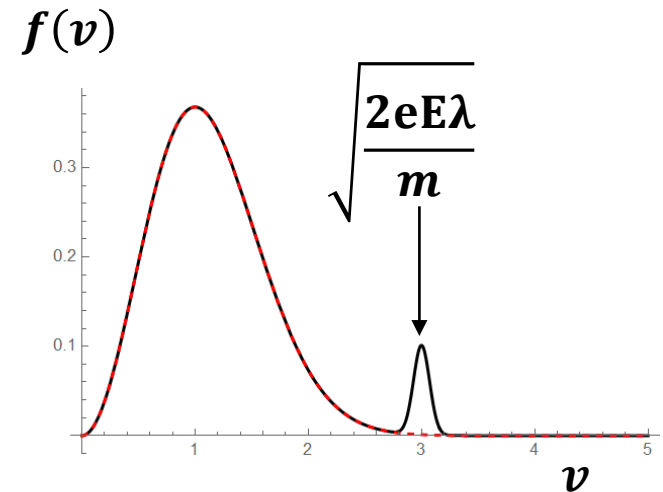

Collisions can be elastic or inelastic



- **Elastic collisions – NO energy exchanges. Momentum is redistributed.**

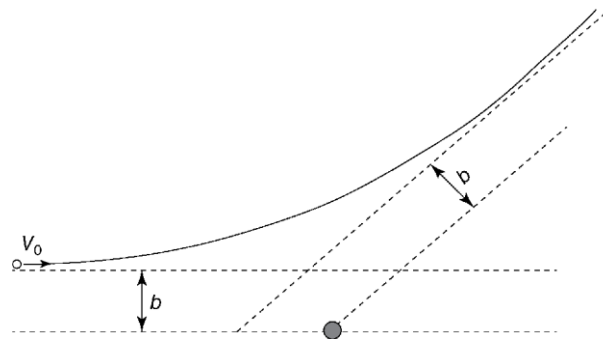

- **Inelastic collisions – energy is exchanged between the collision partners
→ production of molecules & particles.**
 - **A portion of the kinetic energy before collision is converted to potential energy of one of the particles in the system.**
 - **Ionization: $A + B \rightarrow A + B^+ + e^-$**
 - **The process of ionization is dominated by e^- acceleration in an electric field and is greatly aided by the appearance of initiatory electrons: (1) ionization in the gas; (2) emission from the cathode.**

Electron impact ionization is the most important process in a breakdown of gases



- Electron impact ionization: $A + e^- \rightarrow A^+ + e^- + e^-$
 - The most important process in the breakdown of gases but is not sufficient alone to result in the breakdown.

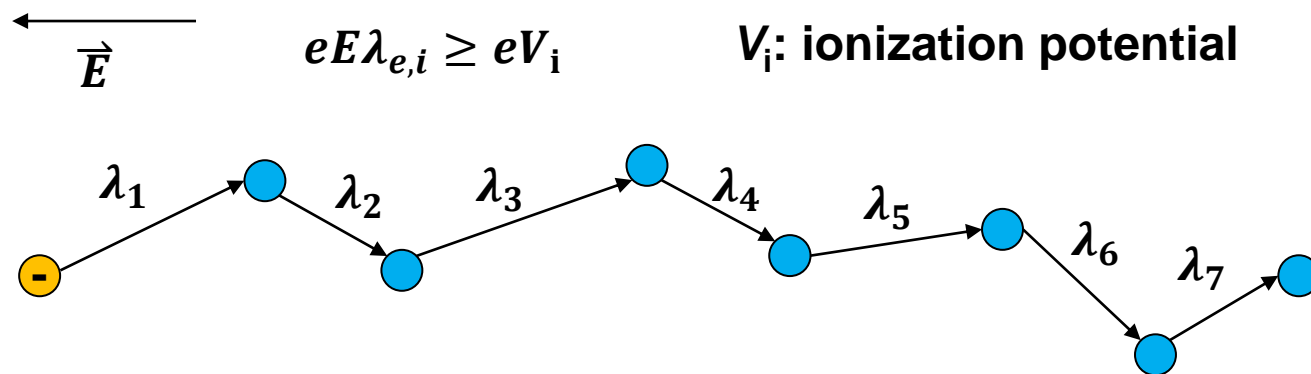

- Inert gas can be ionized easier since there are less exciting state compared to gas molecular.
- Molecular that may absorb electrons is harder to be ionized, i.e., has higher dielectric strength. Ex: SF_6 , O_2 , etc.

Breakdown voltage of different gas

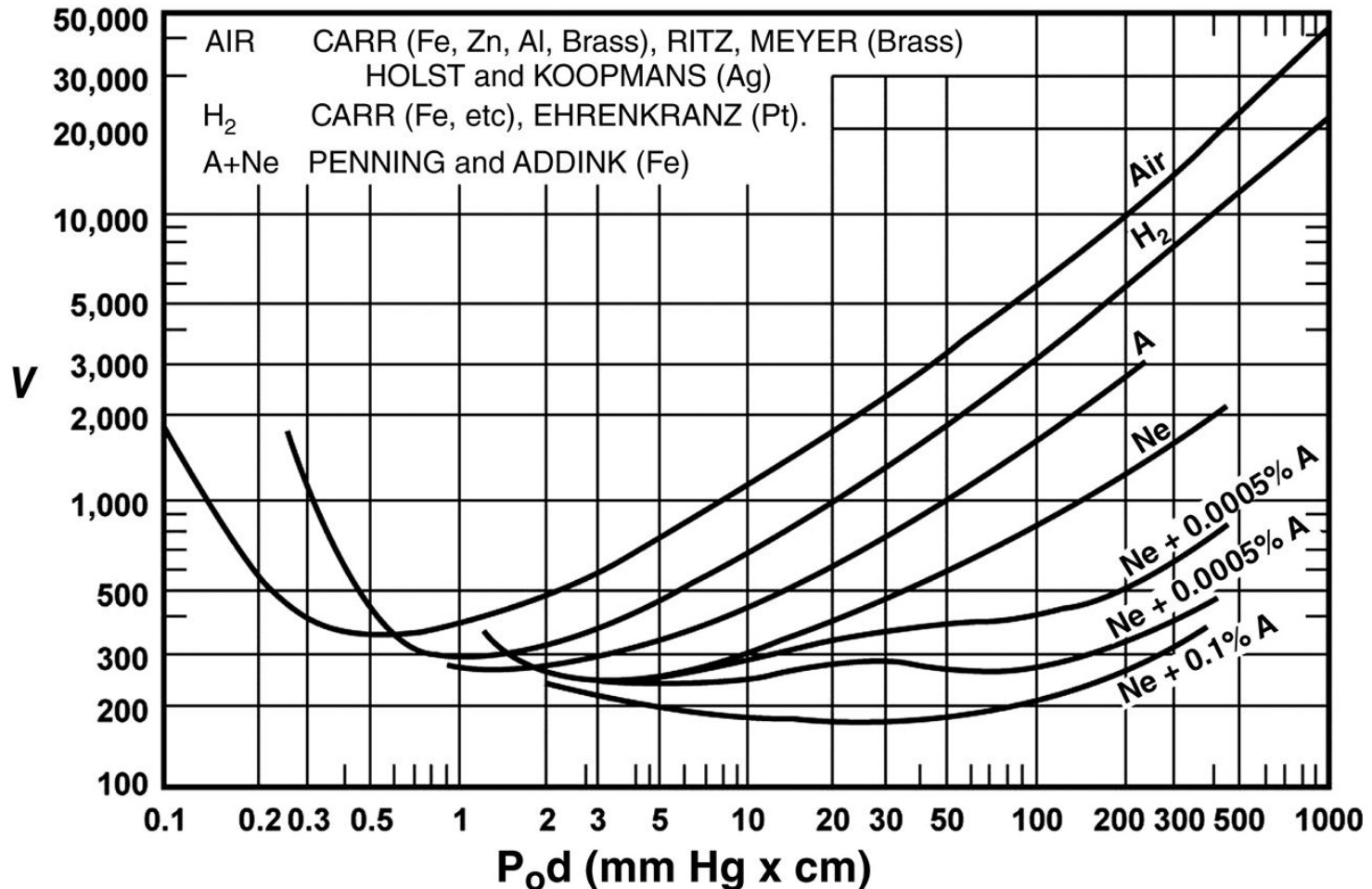

Electric breakdown – Townsend's experiments

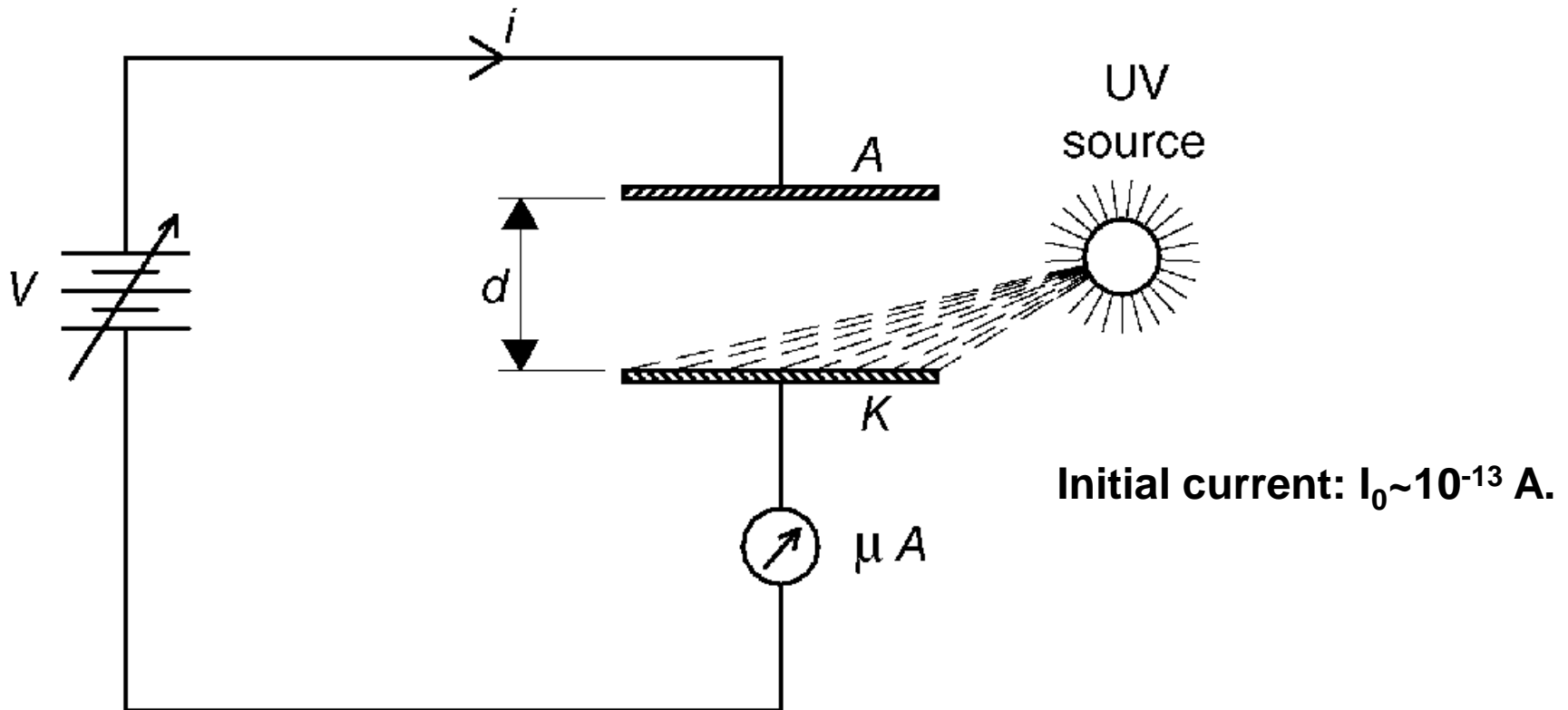

- Initial current can be generated by the static charge on electrode or gas.
- With higher voltage, high current is induced. A spark is produced eventually.

Current grows with a higher voltage



- Photoemission from UV or static charges emitted from electrodes.

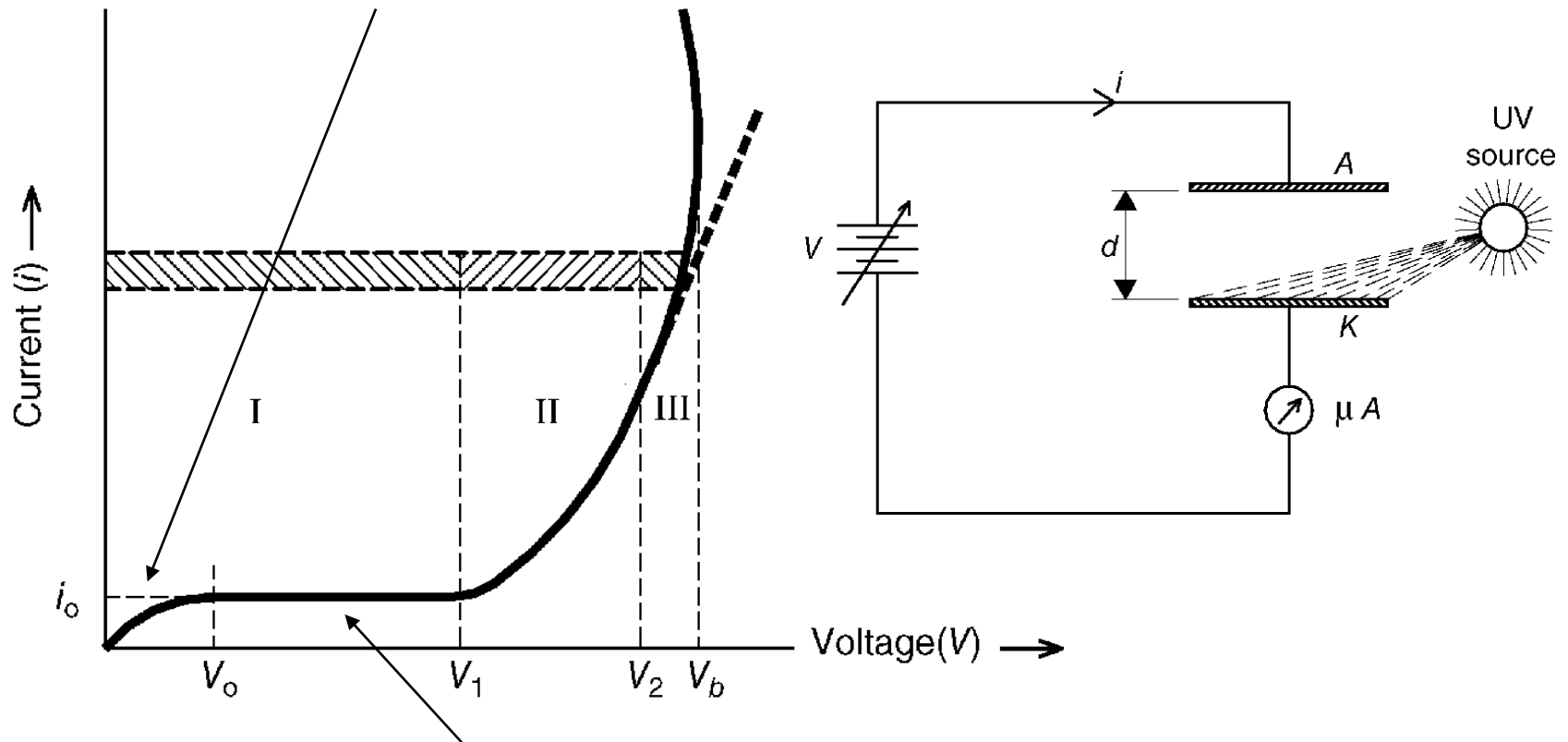

- Electrons emitted from cathode are scattered in random directions colliding with gas molecules.
- The directed averaged drift velocity $>$ average random velocity component.

Section II: the Townsend 1st ionization region



- The current increases exponentially with gap distance.

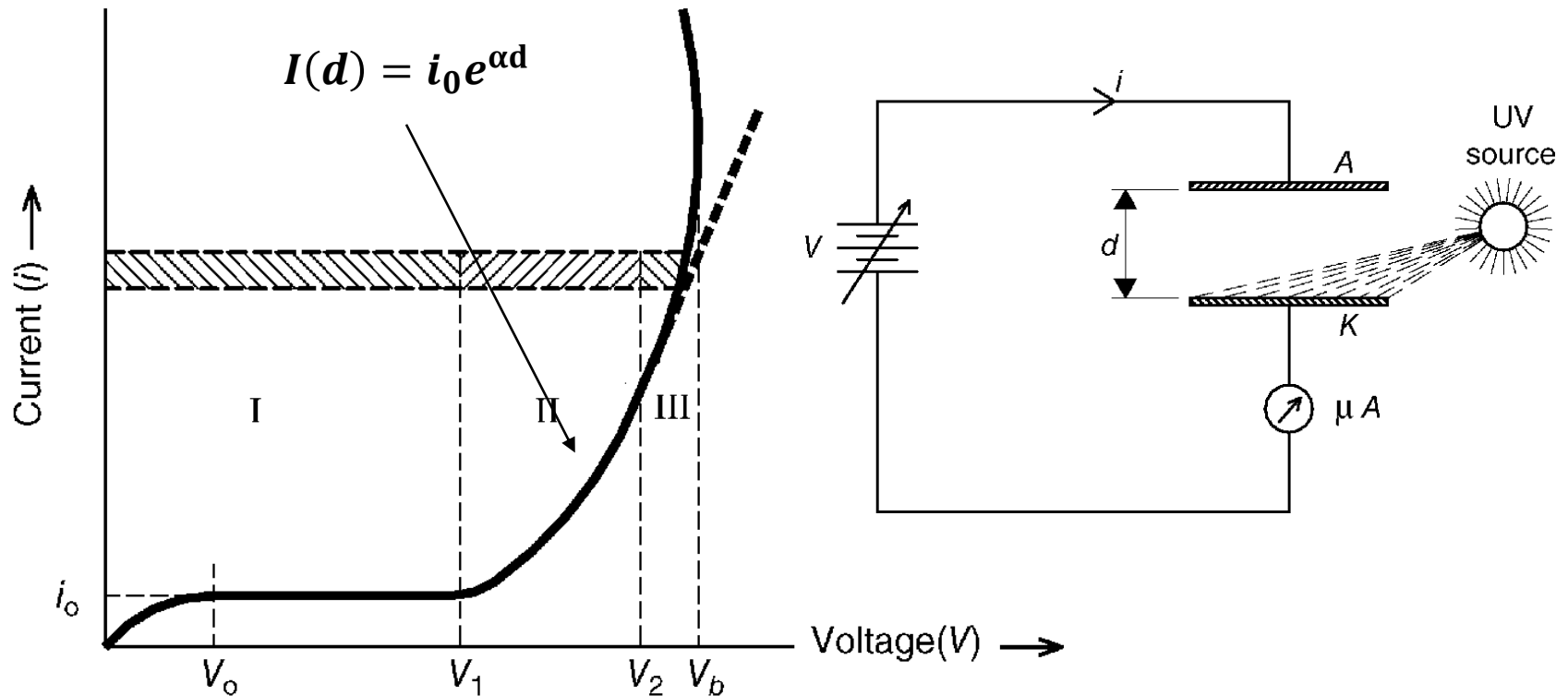

Section III: the Townsend 2nd ionization region



- Single-electron avalanche is not sufficient to carry the circuit-limited current.
- Successor avalanches are formed by positive ions, resulting from ionization collisions with primary electrons, bombarding cathode and liberating more electrons.

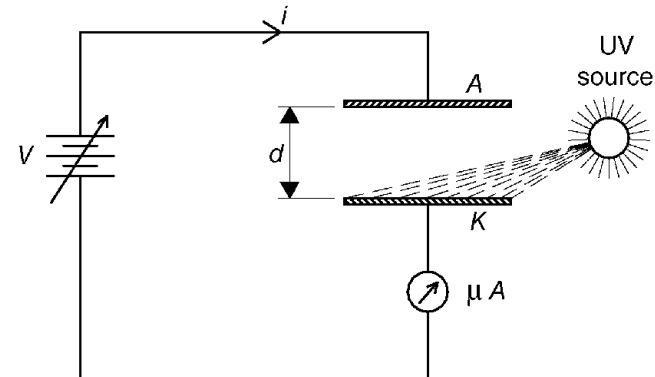
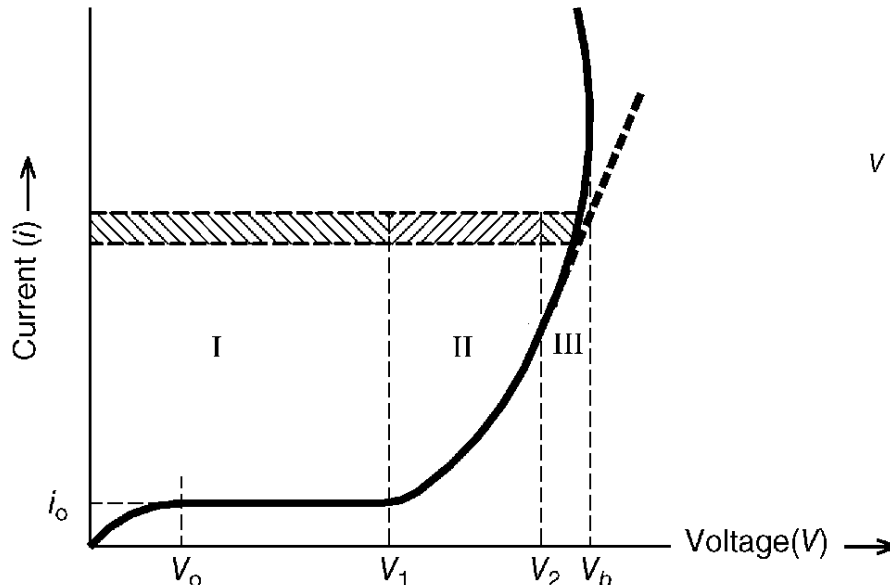

Electron Avalanche: a cascade ionization initiated by a single electron in a uniform electric field



- Present naturally, or photon, or cosmic rays, or static charge.

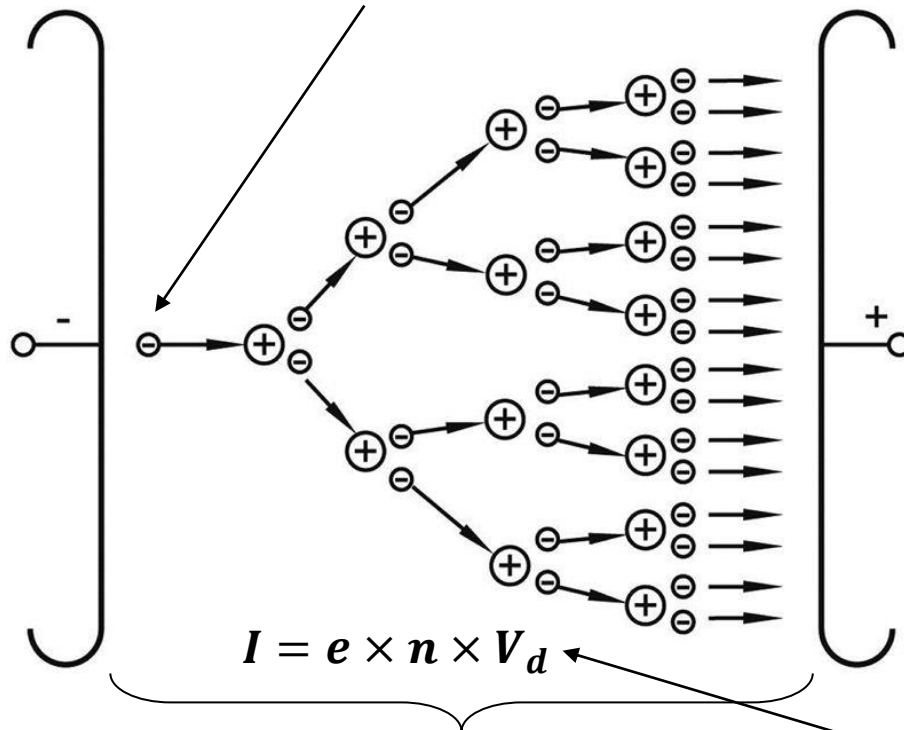

- Cascade ionization

V_d : drift velocity of electrons

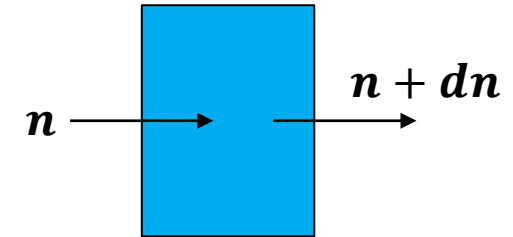

$$dn = n(x)\alpha dx$$

$$\int \frac{dn}{n} = \alpha \int dx$$

$$n(x) = n_0 e^{\alpha x}$$

$$I(d) = i_0 e^{\alpha d}$$

α : Townsend's 1st ionization coefficient

#/ of ionization events performed by an electron in a unit length.

Notice that α/p is a unique function of E/p where p is the gas pressure under normal conditions

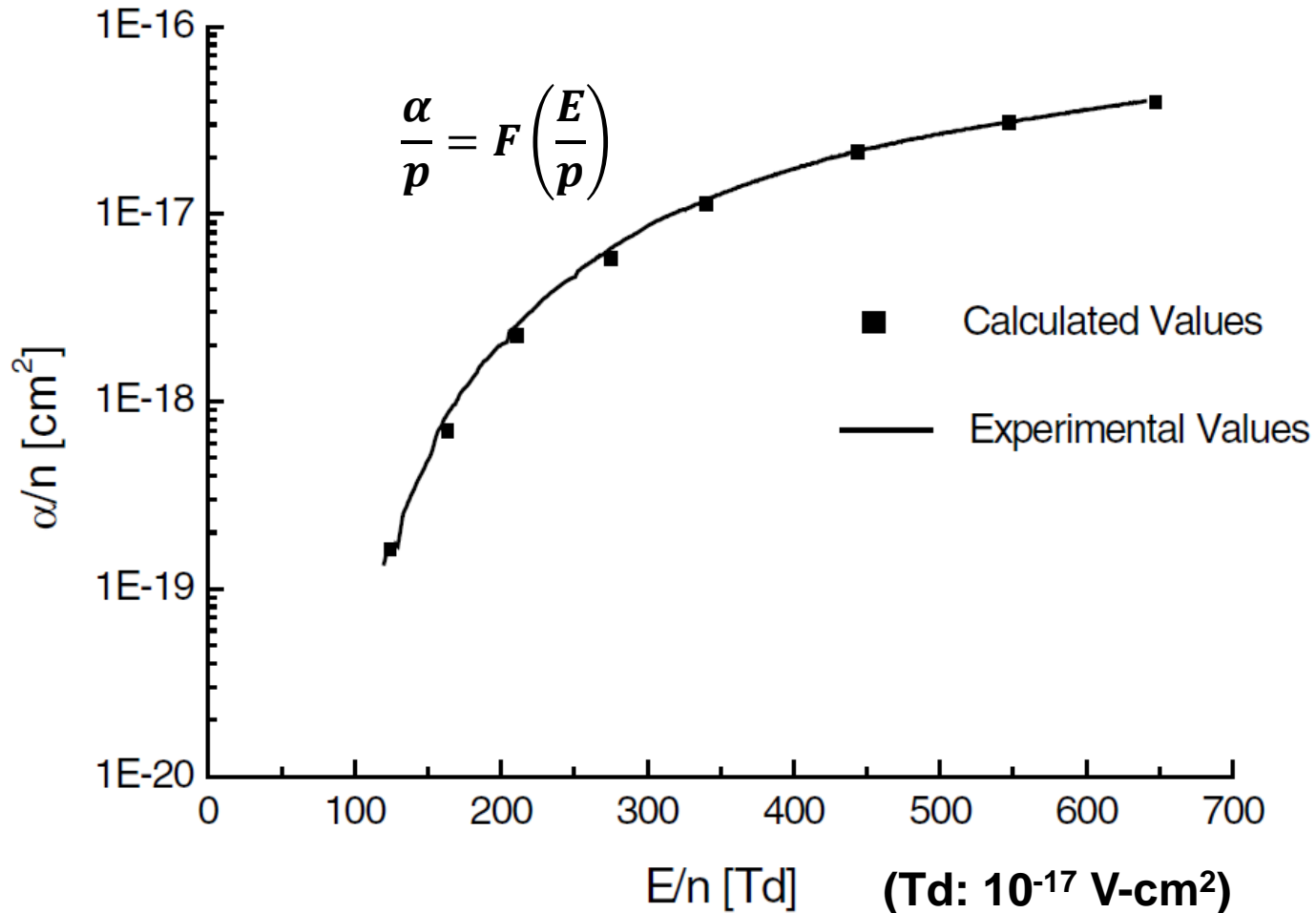

More electrons, secondary electrons, are needed to cause the breakdown



- Secondary electrons – electrons released from the cathode by ions that have drifted to the electrode as well as by light quanta created by recombination and de-excitation processes.

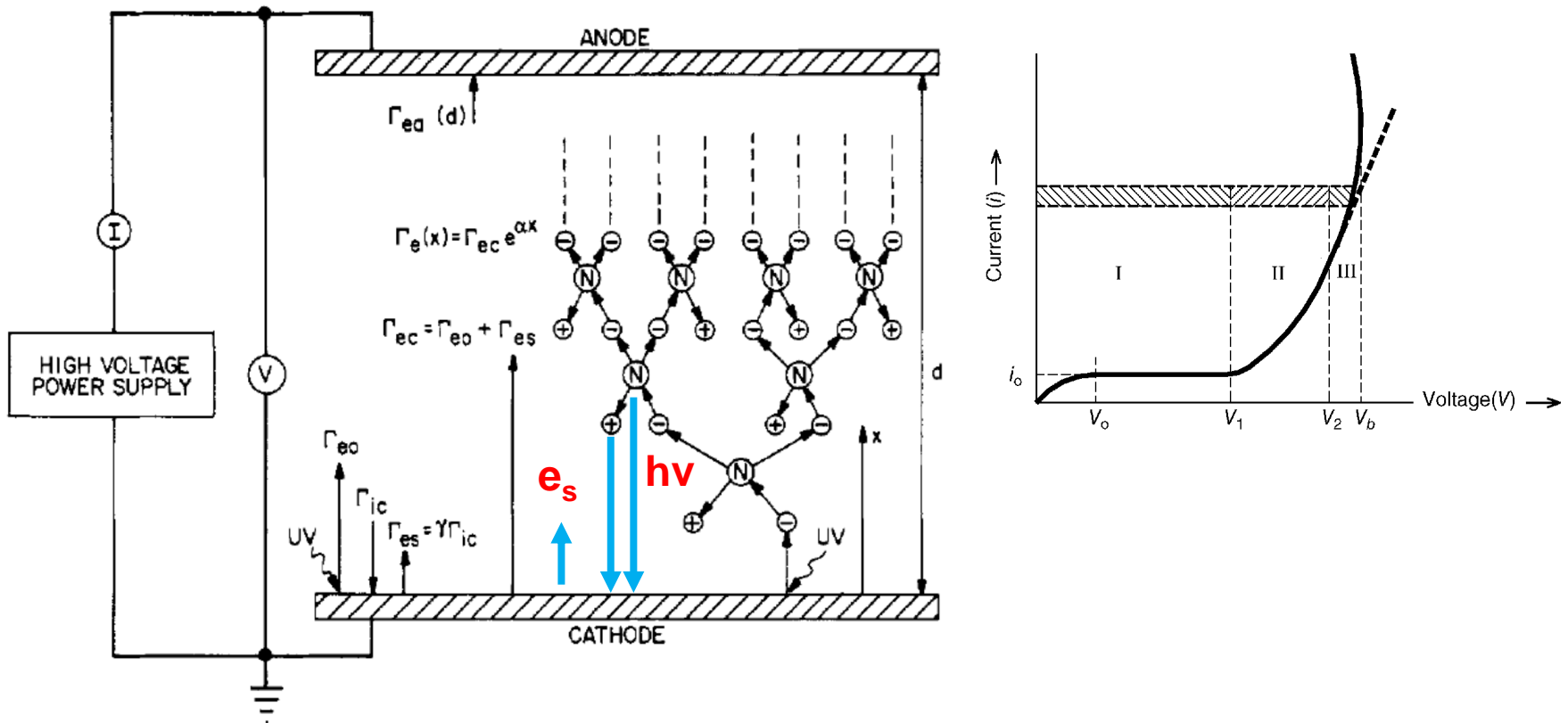

Secondary electrons lead to more electron avalanche



$$\begin{aligned}
 n(0) &= n_0 + \omega \int_0^d n(x) dx \\
 &= n_0 + \omega n(0) \int_0^d e^{\alpha x} dx \\
 &= n_0 + \omega n(0) \frac{1}{\alpha} e^{\alpha x} \Big|_0^d
 \end{aligned}$$

$$n(0) = n_0 + \frac{\omega}{\alpha} n(0) (e^{\alpha d} - 1)$$

$$n(0) = \frac{n_0}{1 - \frac{\omega}{\alpha} (e^{\alpha d} - 1)}$$

$$n(d) = \frac{n_0 e^{\alpha d}}{1 - \frac{\omega}{\alpha} (e^{\alpha d} - 1)}$$

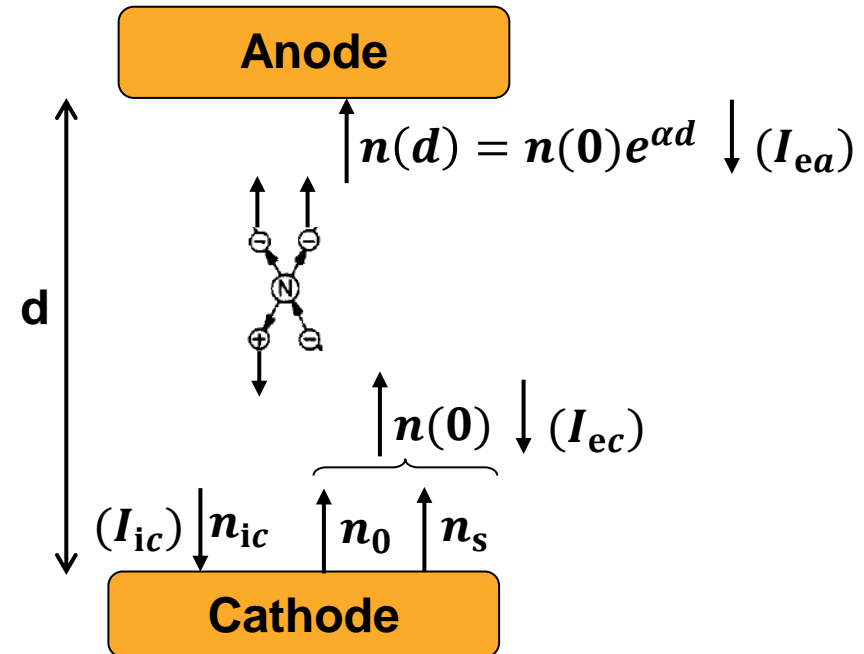

- n_0 : the #/ of electrons released from the cathode by external process.
- ω : coefficient of generating secondary electrons from the #/ of total generated primary electrons.

Secondary electrons generation are strongly dependent on the cathode material



- Multiple secondary electron mechanism:

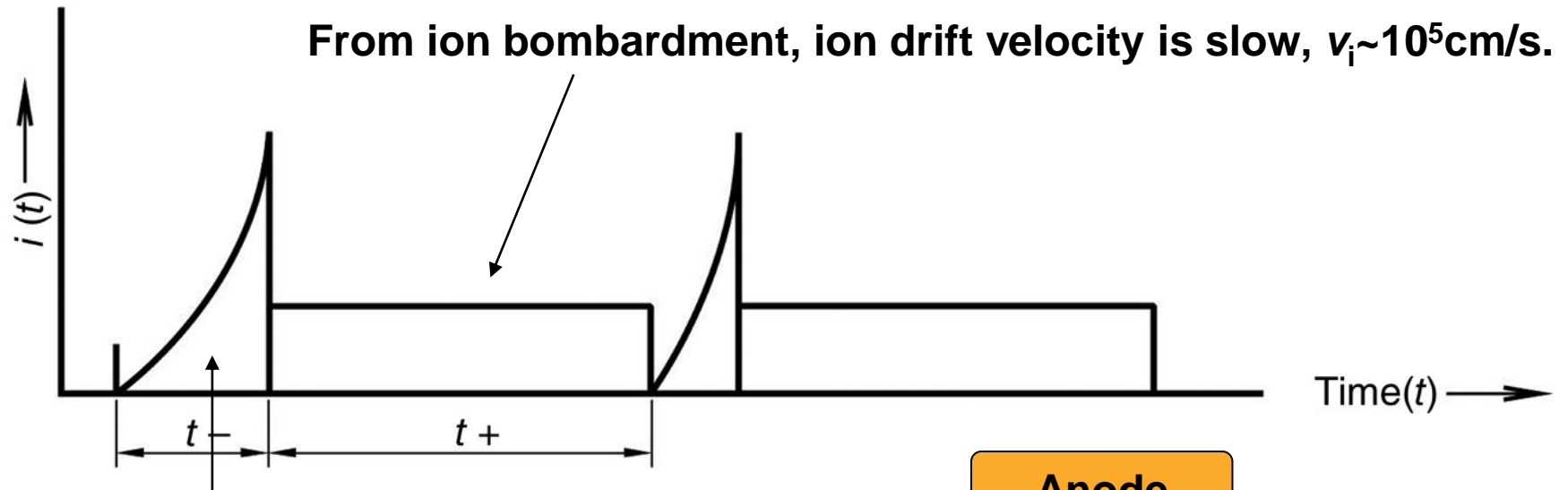

From photon, $v \sim 10^{10} \text{ cm/s}$.

- Time it takes for a breakdown is $\sim d/v_i$.

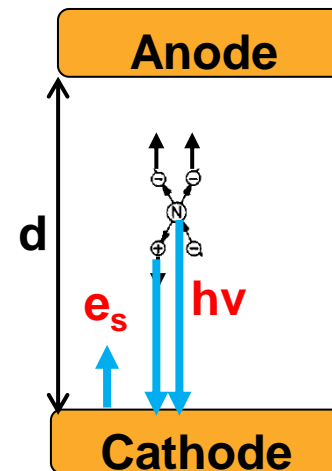

Townsend condition for ignition



- When the denominator equals to zero, the breakdown happens.

$$n(d) = \frac{n_0 e^{\alpha d}}{1 - \frac{\omega}{\alpha} (e^{\alpha d} - 1)}$$

$$1 - \frac{\omega}{\alpha} (e^{\alpha d} - 1) = 0 \qquad \frac{\omega}{\alpha} (e^{\alpha d} - 1) = 1$$

- The insulation of the cathode-anode gap breaks down and a self-sustained discharge is created.

- Experiments show that ω/p is also a function of E/p , i.e., $\frac{\omega}{p} = f\left(\frac{E}{p}\right)$

$$\frac{\omega/p}{\alpha/p} (e^{\frac{\alpha}{p} pd} - 1) = 1 \qquad \frac{f(E/p)}{F(E/p)} (e^{F(E/p)pd} - 1) = 1 \qquad E = \frac{V}{d} \qquad \frac{E}{p} = \frac{V}{pd}$$

- V can be solved for given pd if $f(E/p)$ and $F(E/p)$, i.e., $f(V/pd)$ and $F(V/pd)$ are known.

Paschen's law: the breakdown voltage V_b of a uniform-field gap is a unique function Π of pd



$$V_b = \Pi(pd)$$

- In certain region, A and B are constants for a given gas.

$$\frac{\alpha}{p} = Ae^{-BP/E} \equiv Ae^{-B\frac{pd}{V}} \quad \gamma \equiv \frac{\omega}{\alpha} = \frac{f(E/p)}{F(E/p)} = \gamma\left(\frac{E}{p}\right)$$

- Γ is a slowly varying function of E/p over a wide range.

$$\frac{\omega}{\alpha}(e^{\alpha d} - 1) = 1$$

$$\gamma(e^{\alpha d} - 1) = 1$$

$$\gamma\left(e^{\frac{\alpha}{p}pd} - 1\right) = 1$$

$$\frac{\alpha}{p}pd = \ln\left(1 + \frac{1}{\gamma}\right)$$

$$Ae^{-B\frac{pd}{V}} = \frac{\ln\left(1 + \frac{1}{\gamma}\right)}{pd} \quad e^{B\frac{pd}{V}} = \frac{Apd}{\ln\left(1 + \frac{1}{\gamma}\right)}$$

$$\frac{Bpd}{V} = \ln\left[\frac{Apd}{\ln\left(1 + \frac{1}{\gamma}\right)}\right]$$

$$V_B = \frac{Bpd}{\ln\left[\frac{Apd}{\ln\left(1 + \frac{1}{\gamma}\right)}\right]}$$

Paschen's curve



Gas	A(1/mm-bar)	B(kV/mm-bar)	Range of E/p for validity (kV/mm-bar)
Air	1130	27.4	11-45
N ₂	977	25.5	8-45
H ₂	376	9.8	11-30
He	210	2.6	2-11
Ar	1020	13.5	8-45
CO ₂	1500	34.9	37.75

$$V_B = \frac{Bpd}{\ln \left[\frac{Apd}{\ln \left(1 + \frac{1}{\gamma} \right)} \right]}$$

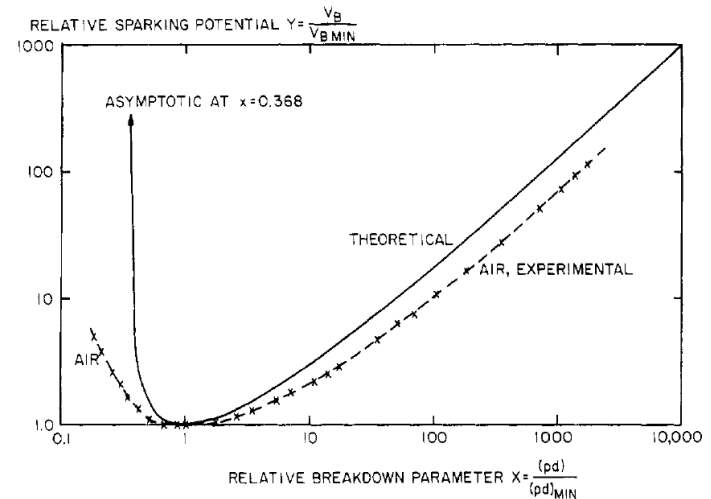

Paschen's curve



$$V_B = \frac{Bpd}{\ln \left[\frac{Apd}{\ln \left(1 + \frac{1}{\gamma} \right)} \right]} \quad x \equiv pd \quad C \equiv \ln \left(1 + \frac{1}{\gamma} \right) \quad V_B = \frac{Bx}{\ln(Ax/C)}$$

$$\frac{dV_B}{dx} = \frac{B \ln \left(\frac{Ax}{C} \right) - Bx \frac{A/C}{Ax/C}}{\left(\ln \left(\frac{Ax}{C} \right) \right)^2} = \frac{B \left[\ln \left(\frac{Ax}{C} \right) - 1 \right]}{\left(\ln \left(\frac{Ax}{C} \right) \right)^2} \equiv 0 \quad \ln \left(\frac{Ax}{C} \right) - 1 = 0 \quad x = e \frac{C}{A}$$

$$pd_{min} = e \frac{\ln \left(1 + \frac{1}{\gamma} \right)}{A}$$

$$V_{B,min} = \frac{Bx}{\ln \left(e \frac{C}{A} \frac{A}{C} \right)} = \frac{Bx}{\ln e} = Bx = eC \frac{B}{A}$$

$$V_{B,min} = e \ln \left(1 + \frac{1}{\gamma} \right) \frac{B}{A}$$

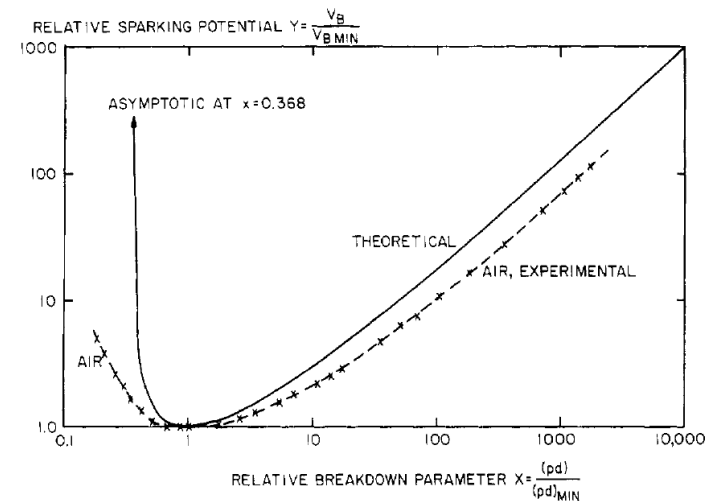

With a voltage lower than $V_{B,\min}$ it is impossible to cause the breakdown of a gap with a uniform field



$$V_B = \frac{Bpd}{\ln \left[\frac{Apd}{\ln \left(1 + \frac{1}{\gamma} \right)} \right]}$$

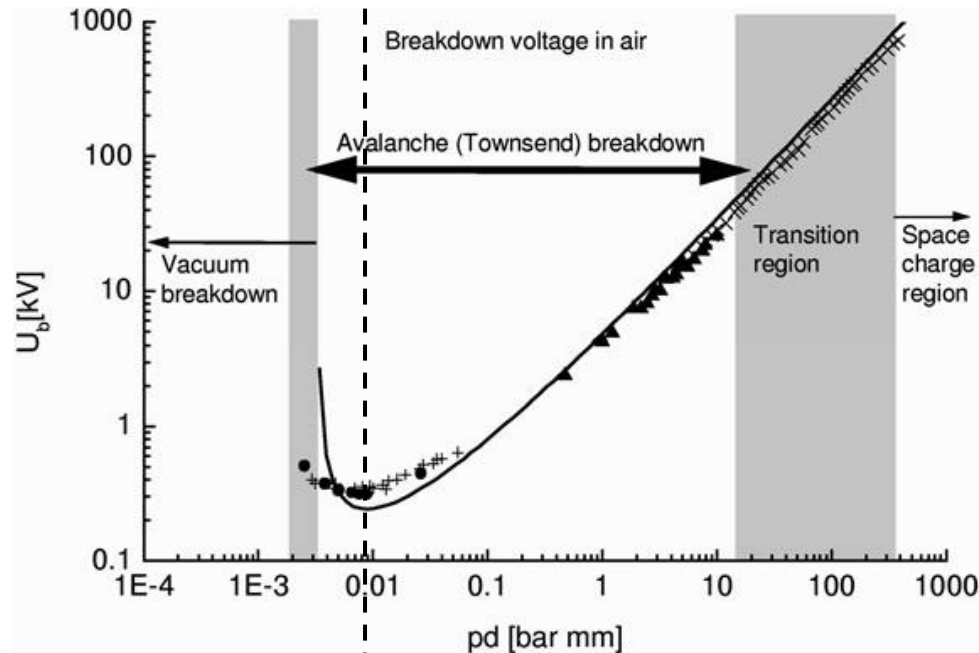

- Collision is not frequent enough even the electrons gain large energy between each collision.
- The minimum of the Paschen's curve corresponds to the Stoletow point, the pressure at which the volumetric ionization rate is a maximum.
- Electrons do not gain enough energy between each collision even collisions happen frequently.

At very high field strengths, field emission of electrons from the electrodes occurs (far left or right of the curve)

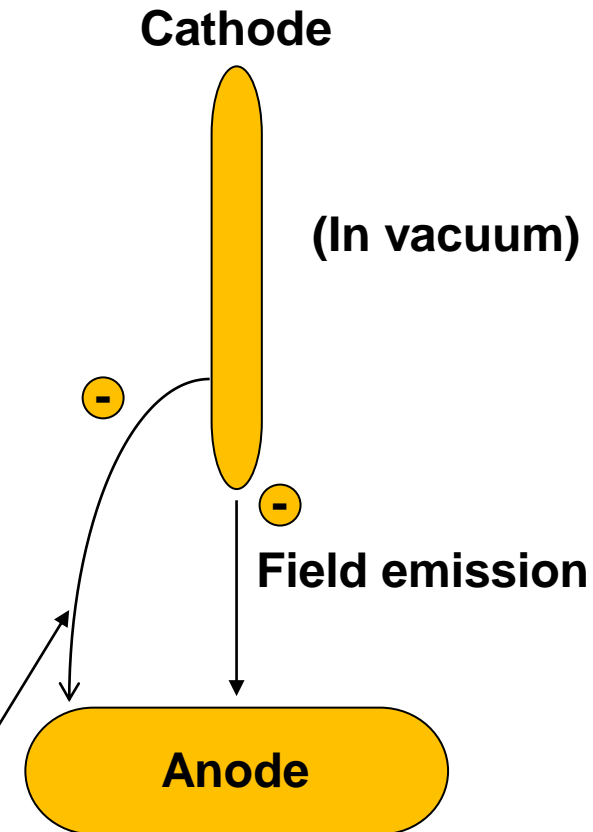
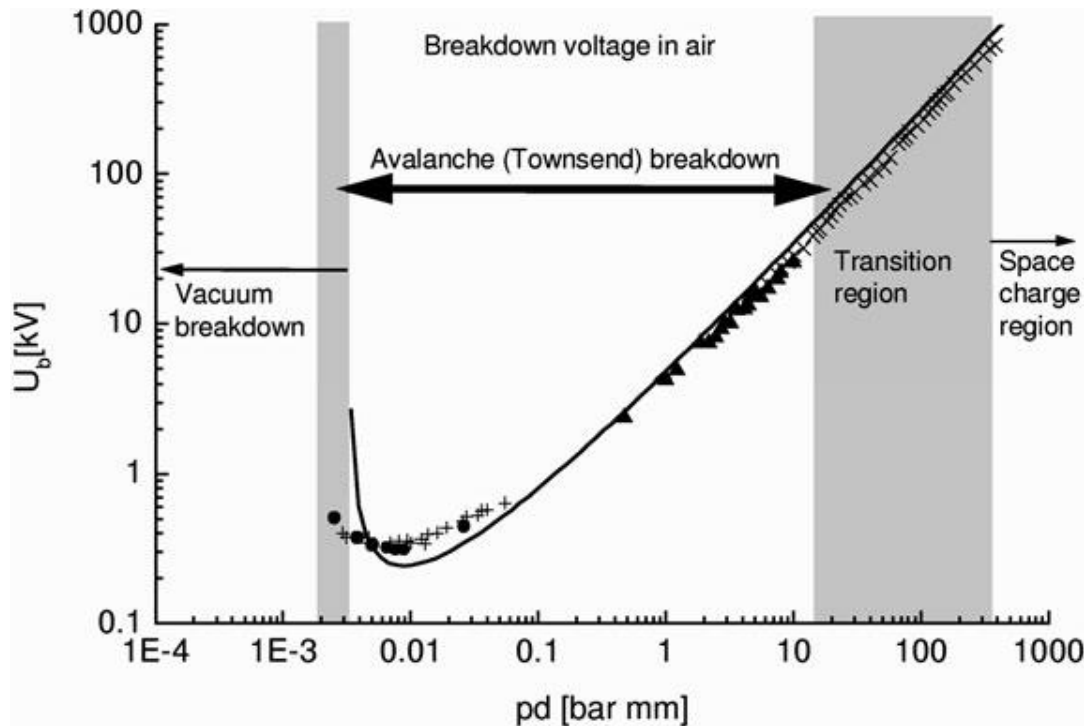

Longer path but more dangerous!

The most commonly used high-strength gas is SF₆

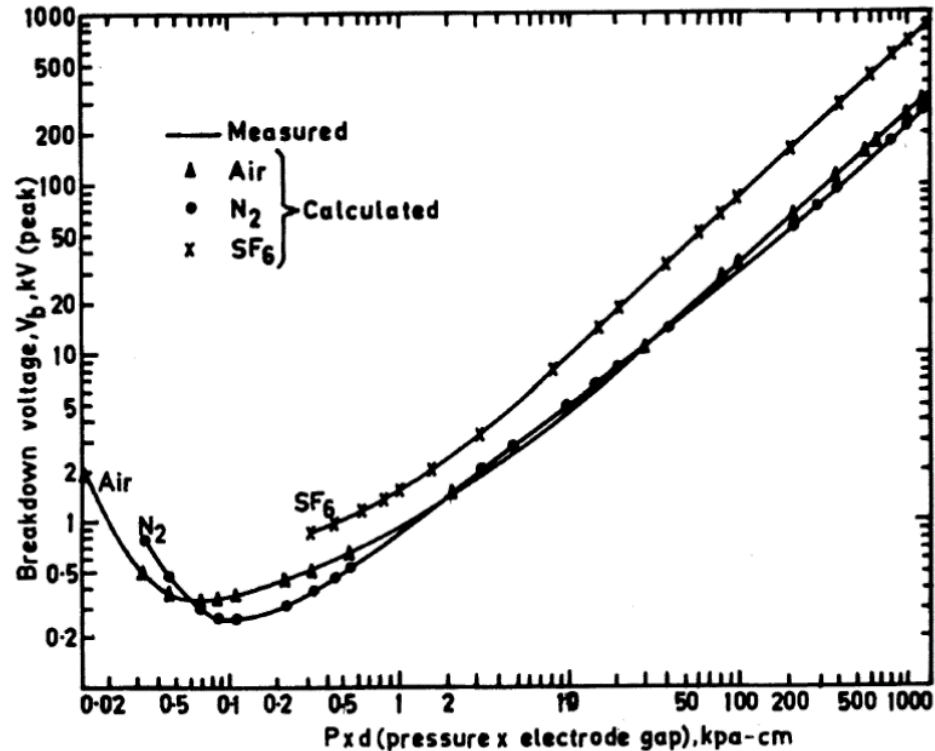

- SF₆ belongs to a group of “electronegative gases,” which are characterized by the ability to attach electrons to the molecule, which then becomes a “negative ion.”
- O₂ has similar effect.

Breakdown voltage is affected by the geometry of the electrodes

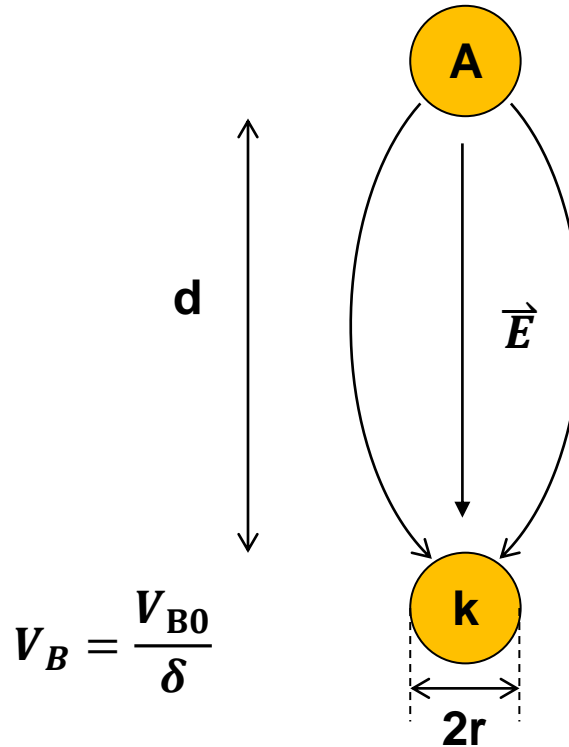
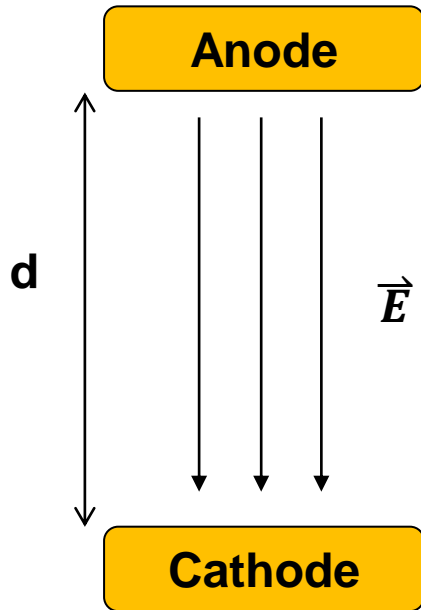

$$V_B = \frac{V_{B0}}{\delta}$$

$$\delta = \frac{x}{2r} \quad x \equiv d - 2r \gg r$$

$$\delta \sim \frac{x}{2r \ln(x/r)} \quad x \equiv d - 2r \gg r$$

$$\delta = \frac{\frac{R}{r} - 1}{\ln(R/r)}$$

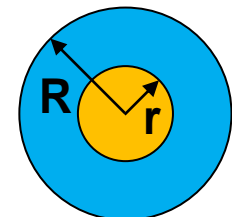

- Equal spheres:
- Equal parallel cylinders:
- Concentric cylinders:

For $E_{\text{needle}} > E_{\text{flat}}$

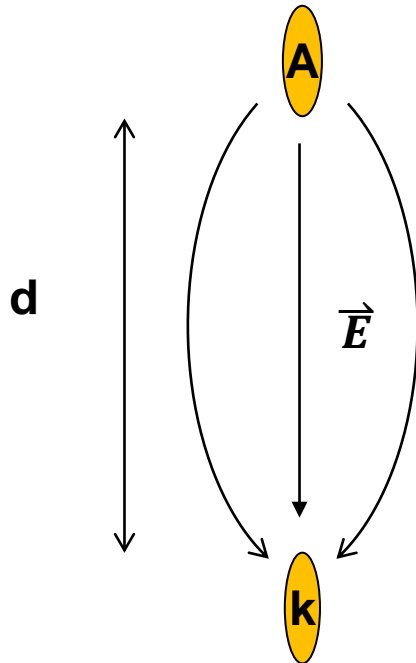

$$V_B = \left(\frac{E}{p}\right)_0 \text{pd}_{\text{eff}} + C(\text{pd}_{\text{eff}})^{1/2}$$

- D_{eff} : it is defined as the distance where the field has dropped to about 80% of its maximum value.

Paschen's curve is used to design different high voltage high current switches in pulsed-power system



- Pulsed-power system

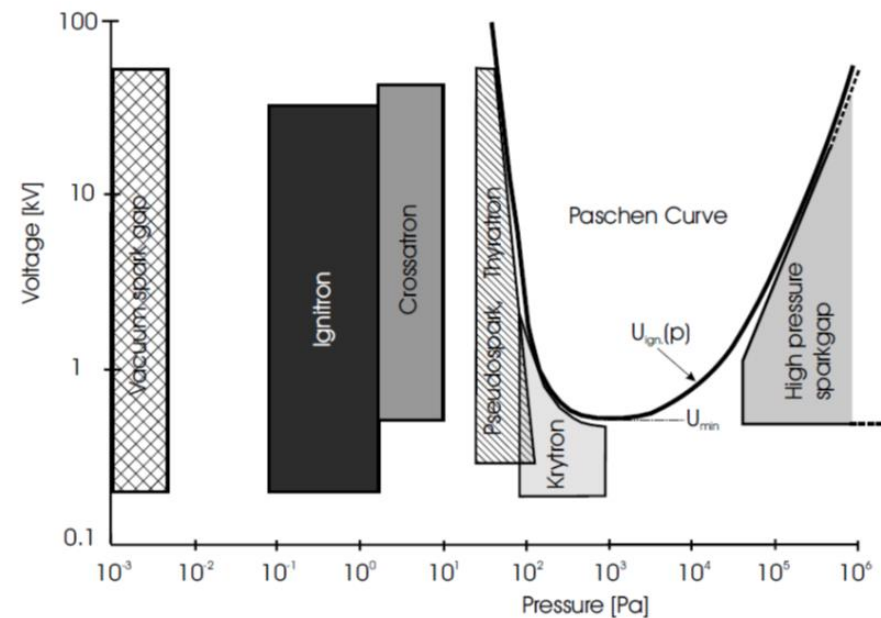
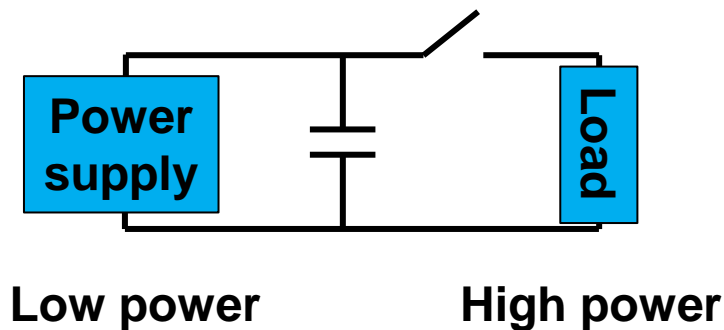

A spark gap switch is closed when electron breakdown occurs

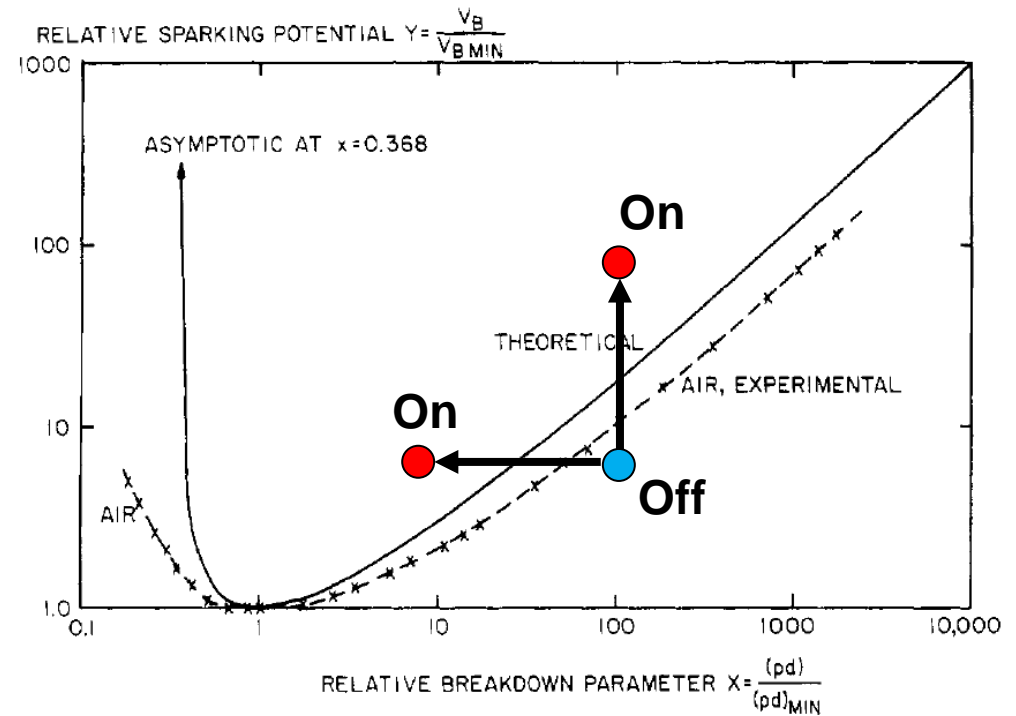
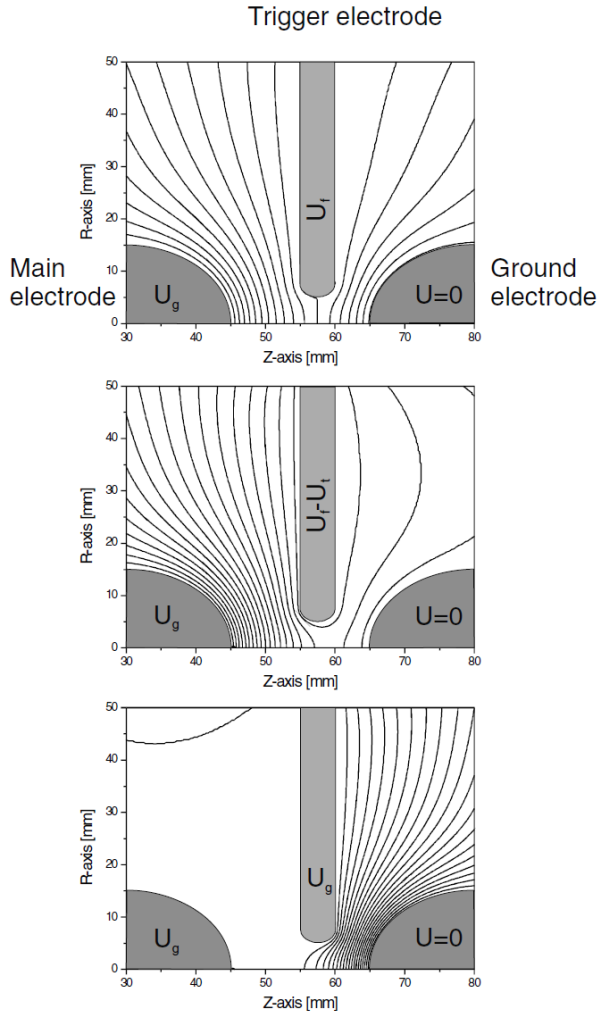

For long, atmospheric air gaps, the discharge time can't be explained by using Townsend's model



- Ex1: $d \sim 1 \text{ cm}$, short delay time ($< 1 \mu\text{s}$)

For Townsend's model, successive avalanche is determined by ion drift velocity:

$$\Delta t \sim \frac{1 \text{ cm}}{10^5 \text{ cm/s}} \sim 10 \mu\text{s}$$

- Ex2: breakdown appears to be independent of cathode material.
- Ex3: Townsend's discharges are developed mostly from the cathode. However, existence of narrow, luminous discharges originating from either the anode or from the middle of the gap may happen!

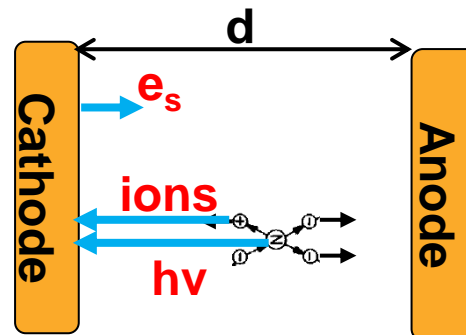

Space charge effect

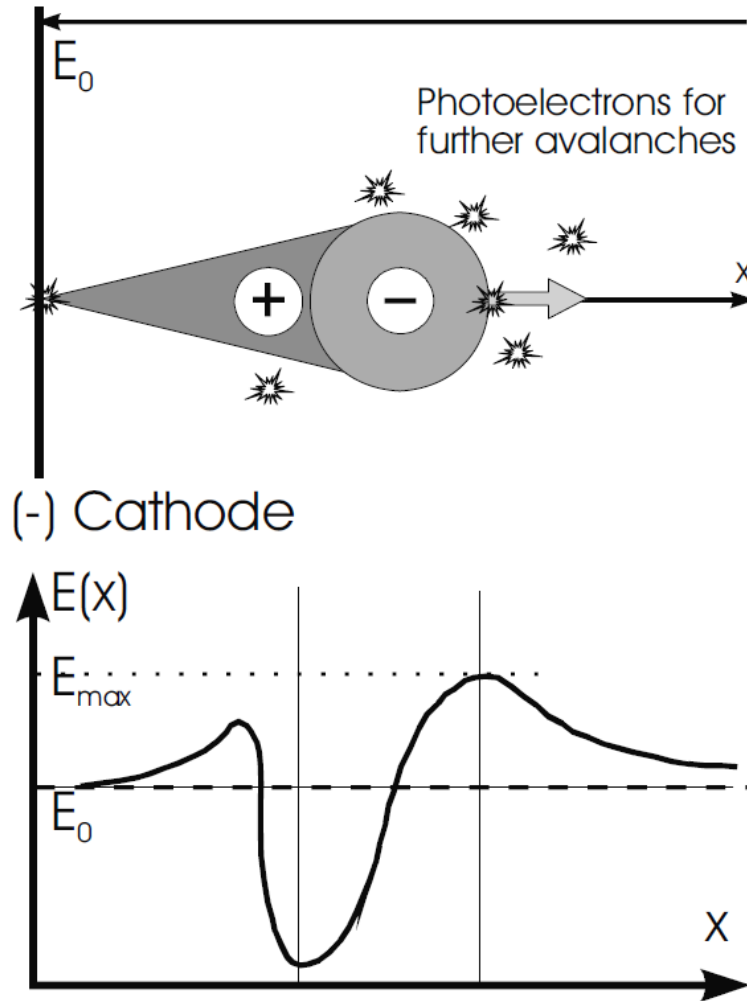

Electrons moving much faster than ions leads to space charge effort which will enhance the avalanche

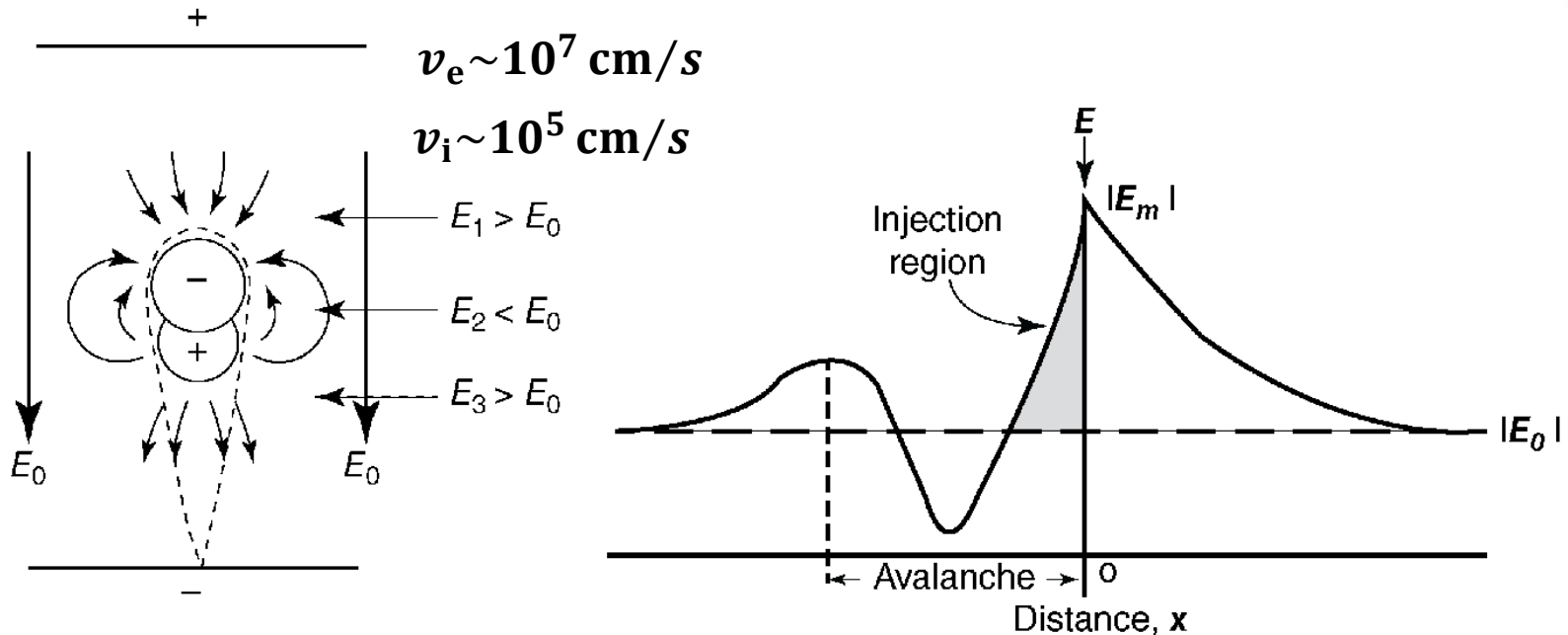

- **Criterion for streamer onset:**

$E_r \sim E_0$ where E_r is generated by the space charge at the head of the avalanche.

or $N_{cr} \sim 10^8$ where N_{cr} is the #/ of electrons in the head of the avalanche.

$$E_{sc} \sim \frac{eN}{4\pi\epsilon_0 r^2} = 1.5 \times 10^6 \frac{N}{(1/\alpha)^2} \text{ V/cm}$$

For $N = 10^7, \alpha = 10^{-2} \text{ cm}$

$$E_{sc} \sim 15 \text{ kV/cm}$$

Streamers



- UV light emitted in recombination and de-excitation creates electrons by “photoionization” ahead and behind the avalanche so that a conducting bridge between anode and cathode is formed.
- Creating photoelectrons at larger distances from the main streamer can advance the growth of the breakdown channel rapidly.
 - $v = 100\text{-}1000 \text{ cm}/\mu\text{s}$ at atmospheric pressure was observed.

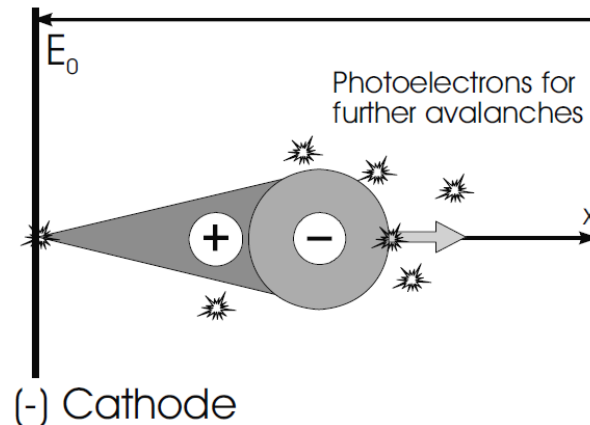

Streamers



- **Streamers - evocative of a thin band of bright light, attached at one end to an electrode and floating toward the other – “kanals”. (Channel in German)**
- **Cathode – directed (positive) streamers, from anode toward cathode.**
- **Anode – directed (negative) streamers, from cathode toward anode.**
- **Single-electron avalanche -> streamer – Streamers develop when the charge density at the head of the avalanche becomes so large that it distorts the applied electric field, i.e., space charge in the avalanche head generates a self-electric field that is on the order of the applied electric field.**

The cathode-directed (positive) streamer (A \rightarrow K)

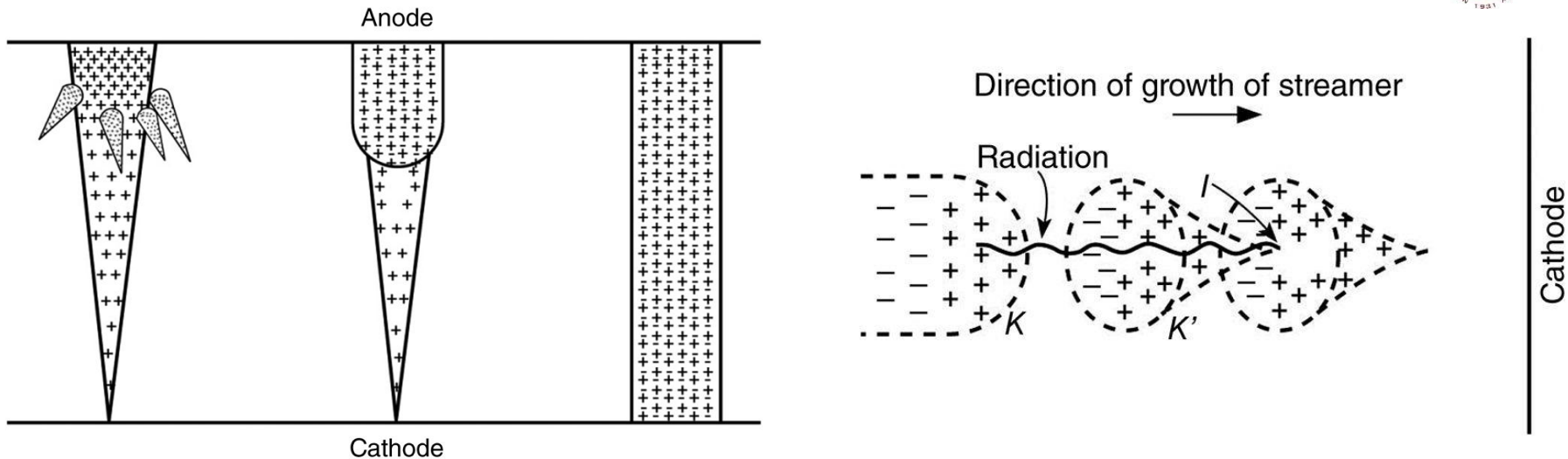

- When the avalanche has crossed the gap, electrons are swept into the anode, the positive ions remaining in a cone-shaped volume extending across the gap.
- The streamer grows with the help of photonization.

The anode-directed (negative) streamer (k → A)



- Negative streamer

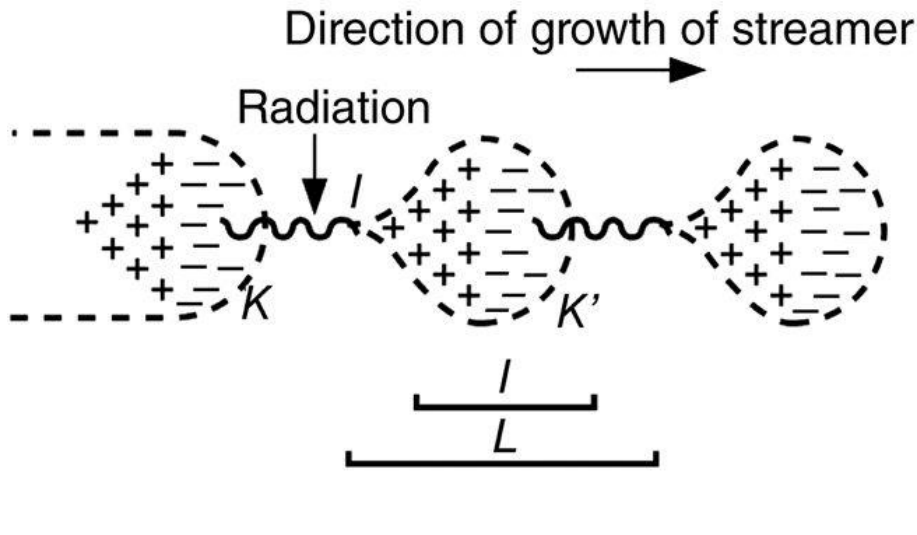

- Positive streamer

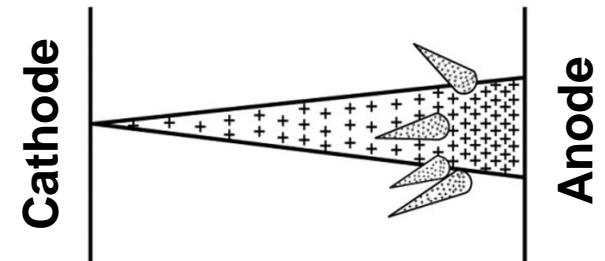

- The negative streamer happens when the primary avalanche becomes sufficiently strong before reaching the anode.
 - $N_{cr} \sim 10^8$ where N_{cr} is the #/ of electrons in the head of the avalanche.

The overvolted streamer

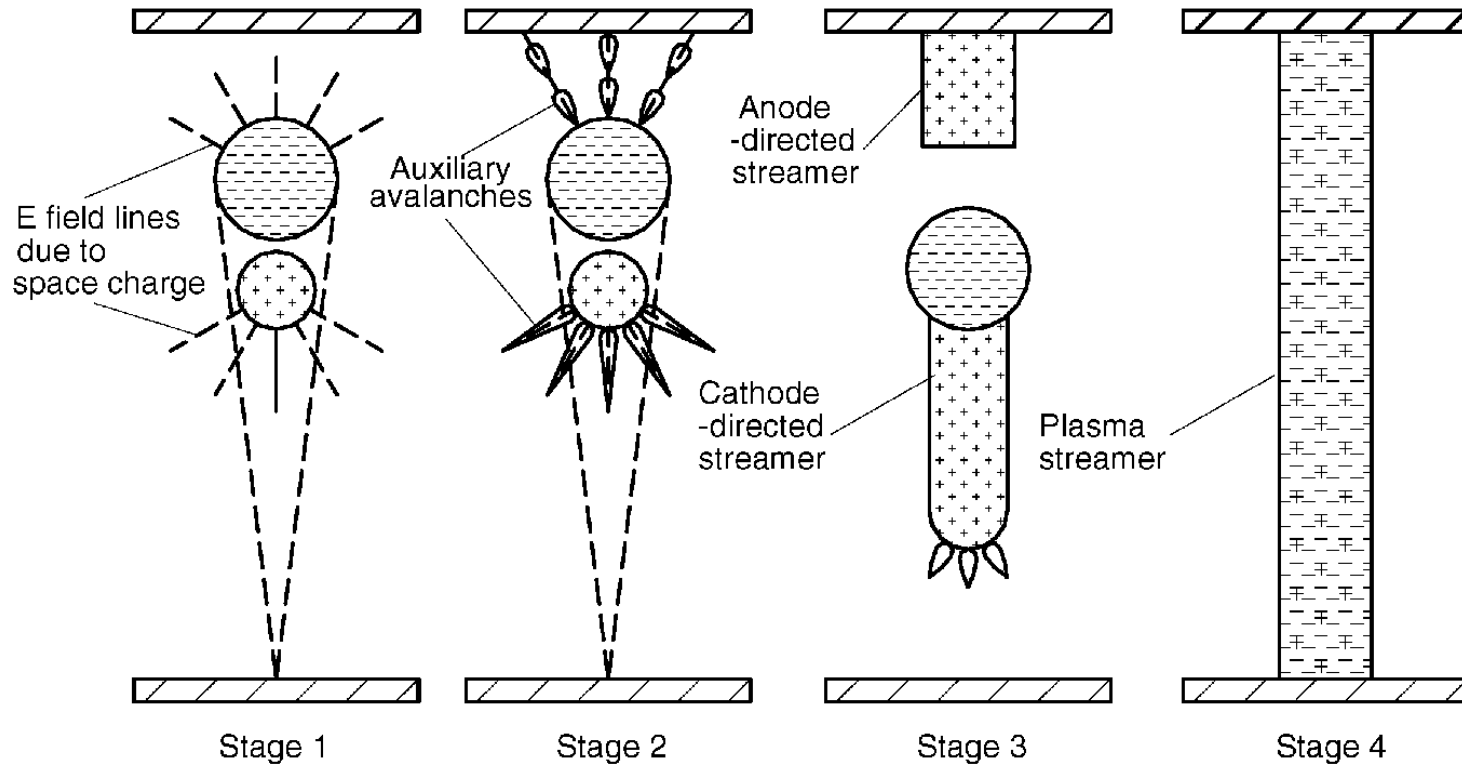

A voltage cross the gap higher than the static breakdown voltage occurs in a pulsed breakdown



- If a fast-rising pulse across the gap, we must take into account the fact that it takes a finite time before a breakdown can occur.
- Free electrons can be created by illuminating the gap volume or the cathode surface with electromagnetic radiation, in particular UV light, x rays and γ radiations.

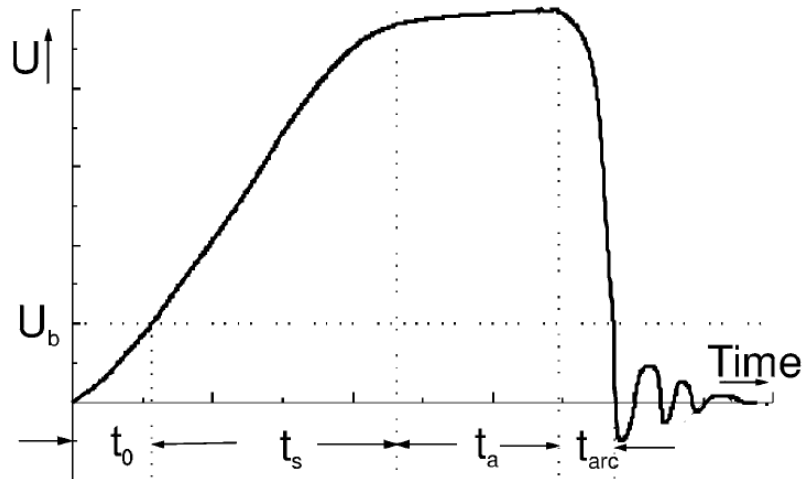

- U_b : The static breakdown voltage.
- t_0 : the time until the static breakdown U_b is exceeded.
- t_s : statistical delay time until an electron is able to create an avalanche resulting from the statistics of electron appearance.
- t_a : the avalanche build-up time until the critical charge density is reached.
- t_{arc} : the time required to establish a low-resistance arc across the gap.

The corona discharge – a small current leakage across a gap before a breakdown happens



- **Corona is a luminous, audible discharge that occurs when an excessive localized electric field gradient causes ionization in the surrounding gas.**
 - **Luminous discharge:** colored glow, frequently visible in darkened environment.
 - **Audible discharge:** a subtle hissing sound, louder with high voltage.
- **It manifests easily in highly nonuniform electric field geometries, such as point-to-plane electrodes or cylindrical geometries with inner conductors made of wire.**

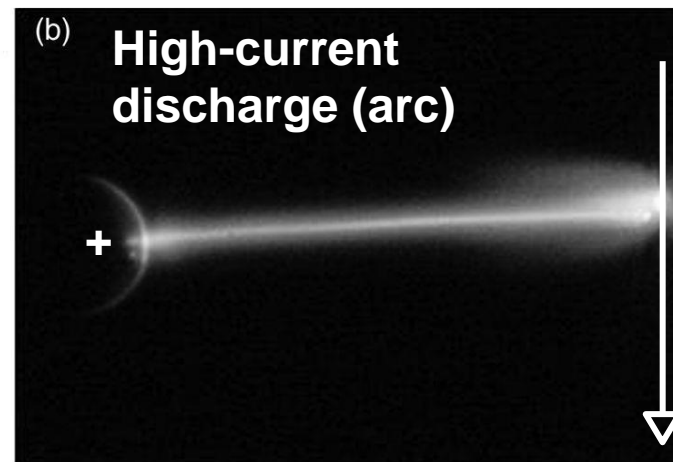
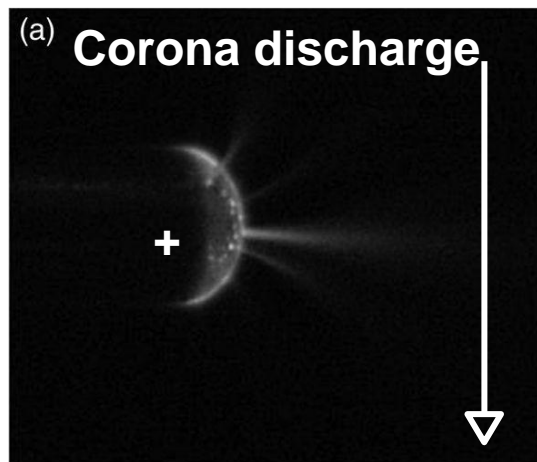

Don't bring a long stick to a train station

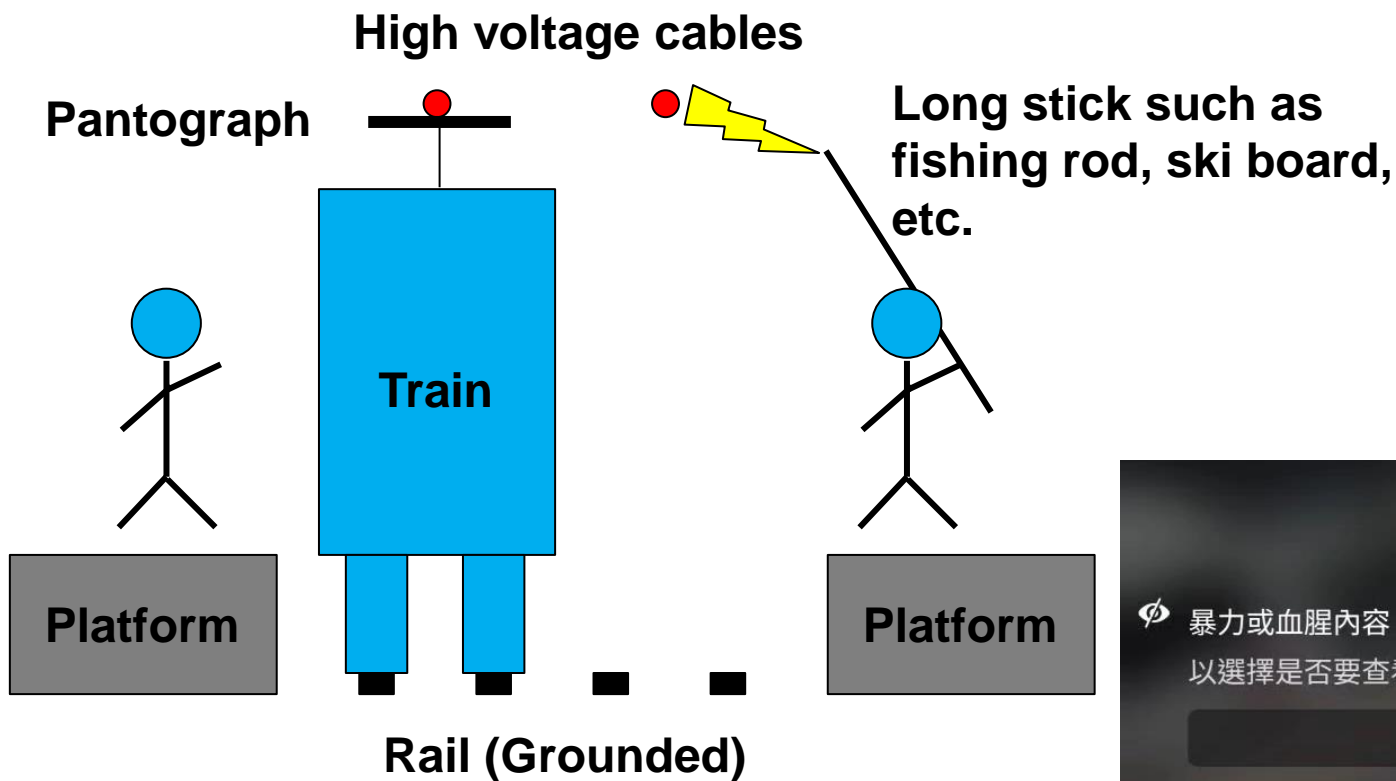

⚡ 暴力或血腥內容。這段影片已遮蔽，用戶可以選擇是否要查看。

[瞭解詳情](#)

The corona discharge happens when the electric field is not uniform

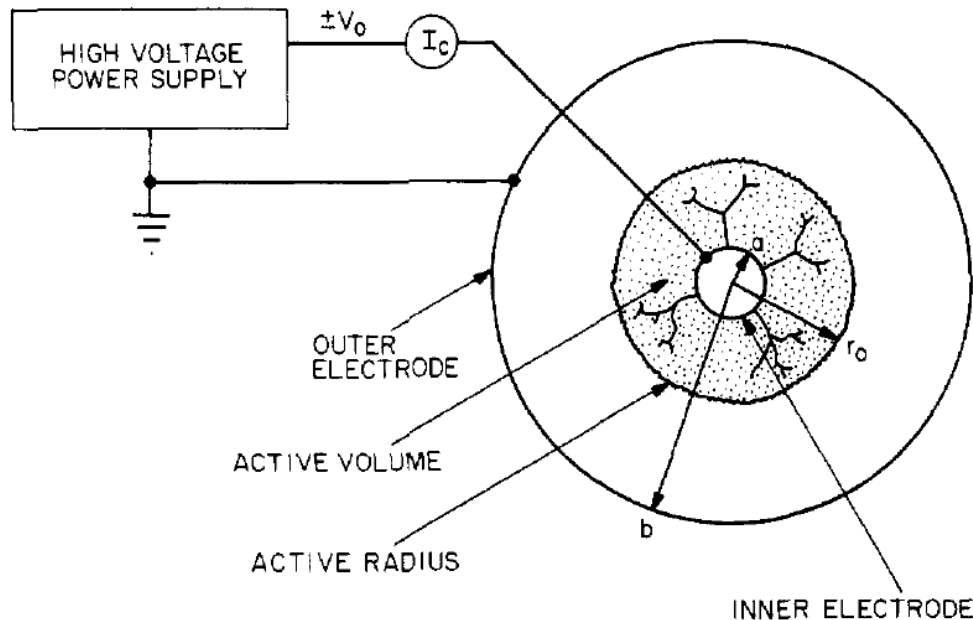

- The point of corona initiation is that point at which the voltage on the inner conductor of radius a is high enough that corona is just detectable.
- The electric field will drop off to the breakdown value at a radius r_0 called the active radius.
- Electrons are attached to molecular forming negatively charged ions to close the current loop. No additional avalanche can happen.

Corona can occur for both positive and negative polarity



- **Positive polarity**

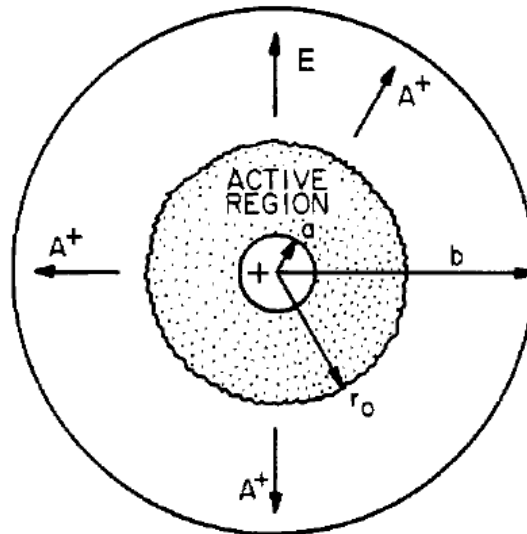

- **Negative polarity**

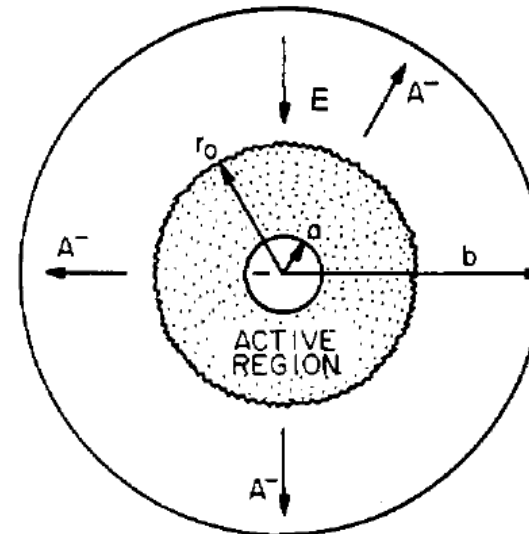

- The initiation voltages or coronal current are slightly different between positive and negative polarity.
- A continuous (positive polarity, DC) or intermittent (negative polarity, usually) current, usually in the order of $\mu\text{A} \sim \text{mA}$ per decimeter of length will flow to the power supply.

Negative point corona, also known as Trichel pulses

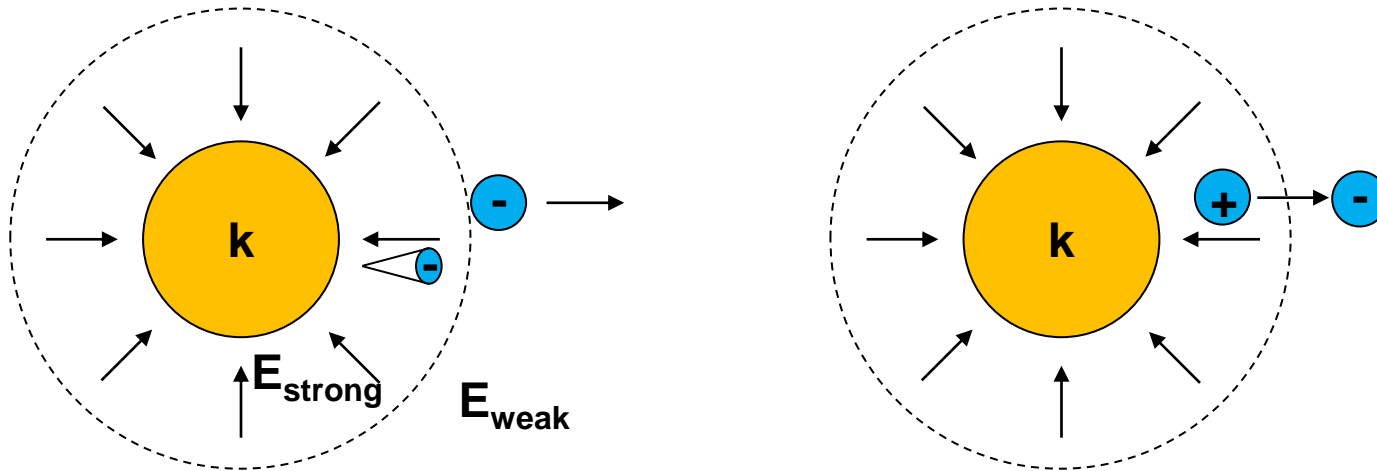

- **Avalanche toward anode occurs in the strong electric field region.**
- **No further ionization occurs in the weak field region.**
- **Electrons are slow down by positively charged ions (ion+) behind.**
- **Electrons attach to gas molecules forming negatively charged ions (ion-).**
- **The presence of the negative ions reduces the electric field at the point electrode and the discharge extinguishes.**
- **When positively/negatively charged ions drifted away, the original high-field conditions are re-established**

Positive point corona

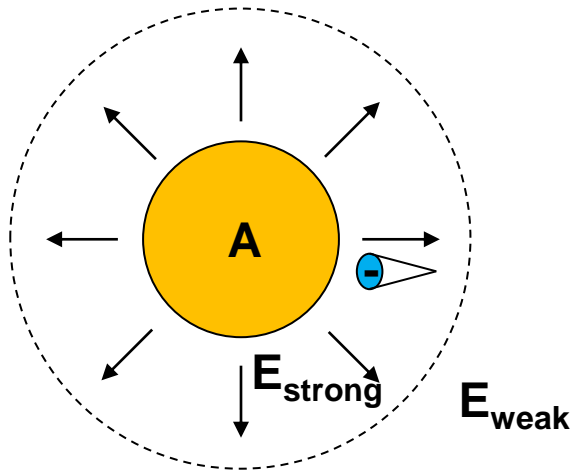

- **Electron avalanche initiated near the high-field region propagating toward anode.**
- **Streamer is developed.**
- **Lateral avalanches feed into the streamer core.**
- **Negative ion cloud is formed**

A corona discharge causes some problems even no breakdown occurs



- Ozone (O_3) is generated.
- Rubber is destroyed by O_3 .
- NO_3^+ is generated with moisture.
- Disadvantage:
 - Power losses.
 - Radio frequency (RF) interference.
 - Reduce the service life of solid and liquid insulation via initiating partial discharge.
 - Chemical decomposition.
- Advantage:
 - Pseudospark discharge – fast switch.
 - Electrostatic precipitator (dust remover) using corona discharge.

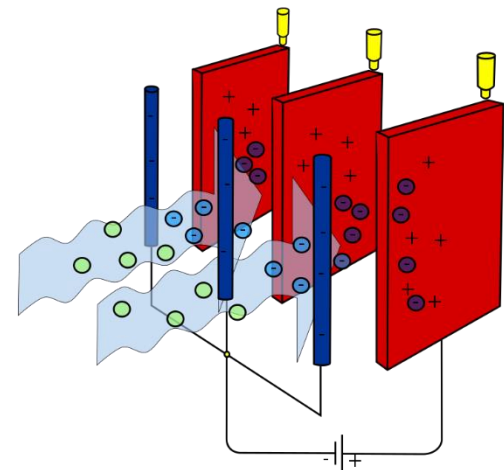

Tesla coil can generate high voltage

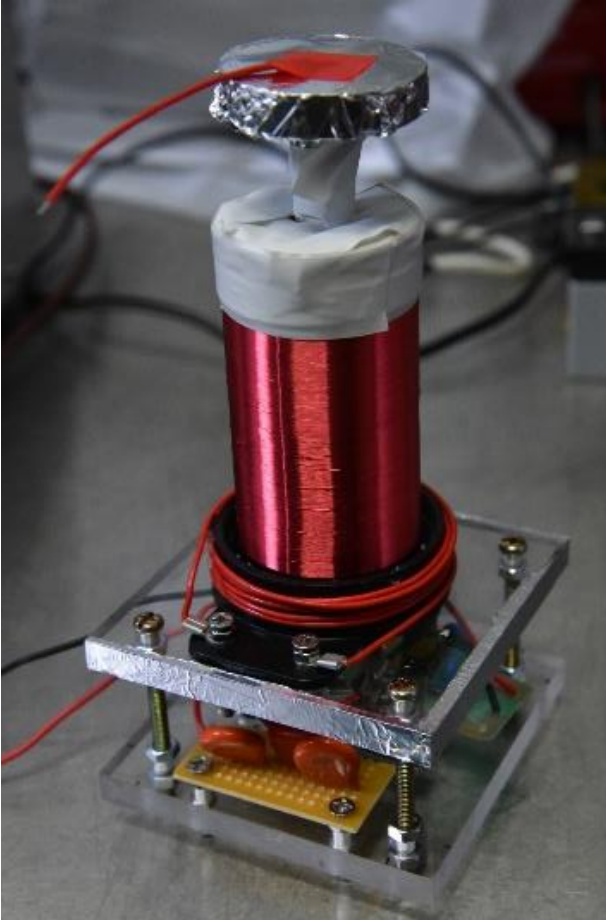

The high voltage is generated by two resonant LC circuits

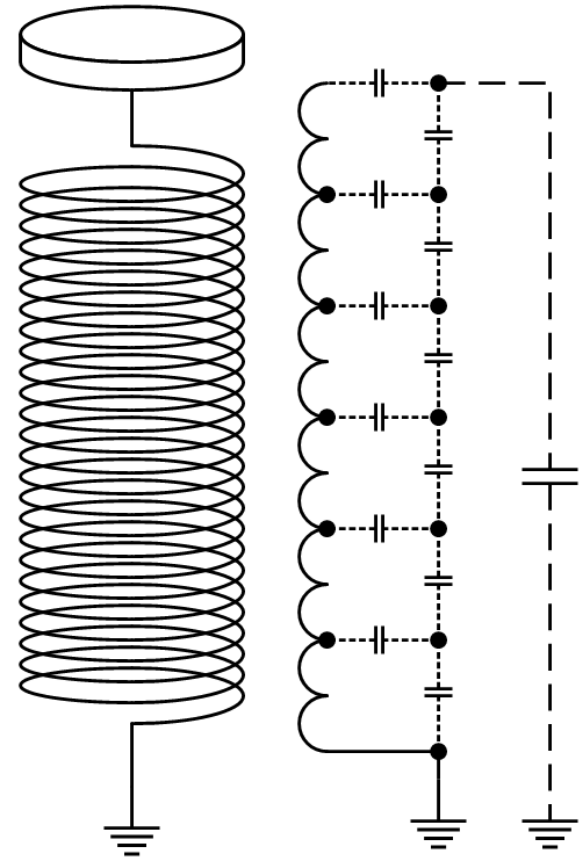
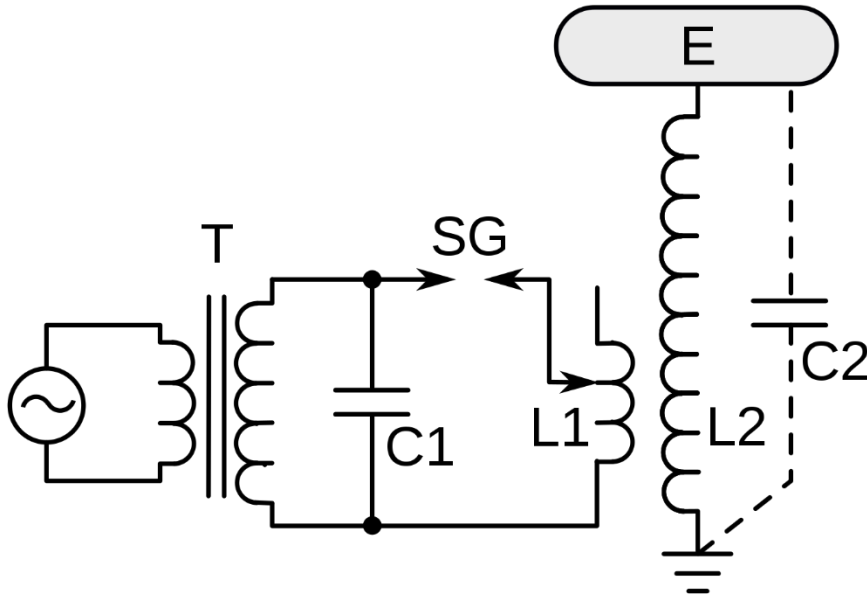

Energy is oscillating between the capacitor and the inductor

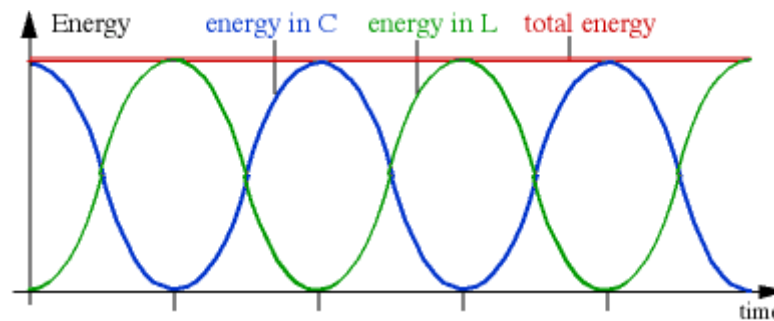
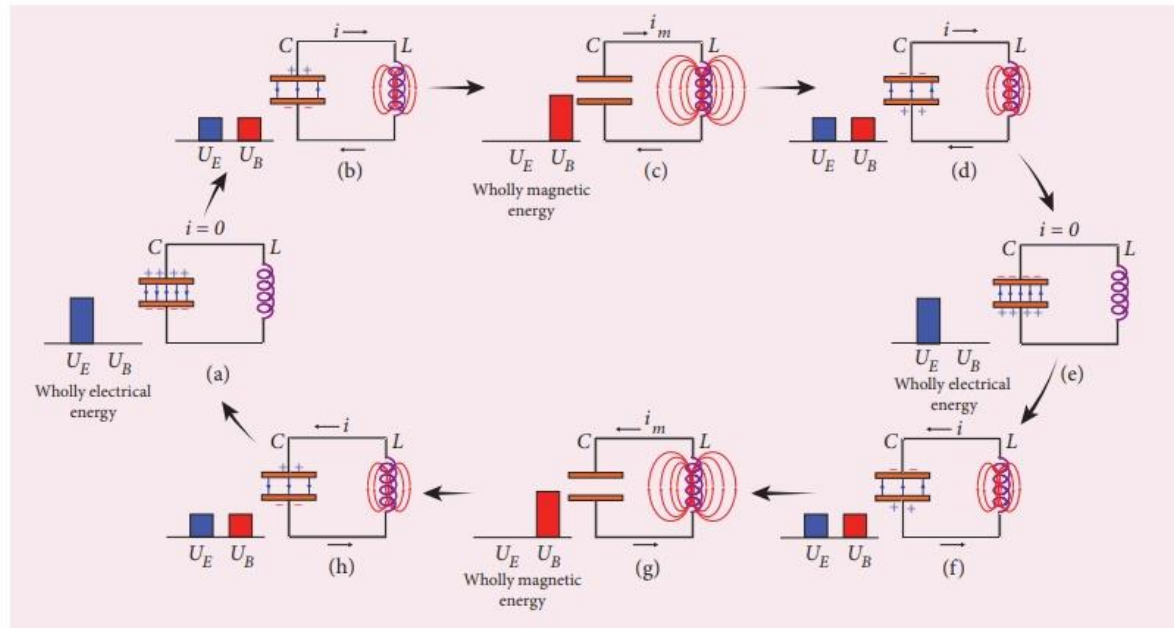

https://www.brainkart.com/article/Energy-conversion-during-LC-oscillations_38532/

http://ffden-2.phys.uaf.edu/webproj/211_fall_2016/Mark_Underwood/mark_underwood/Primary.html

Voltage of two separated coils can be transferred by mutual inductance between two coils

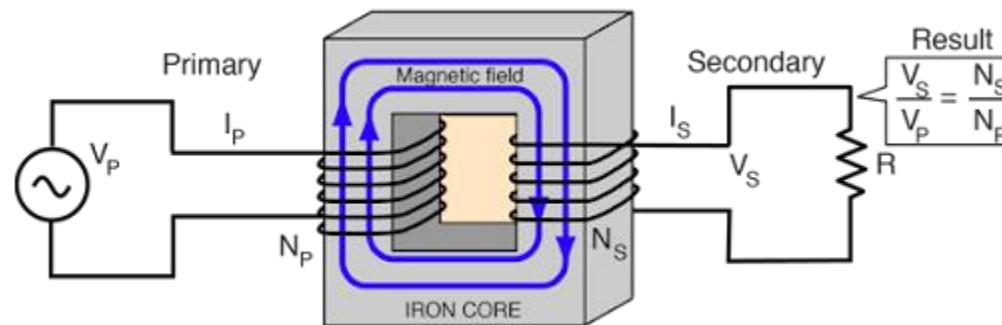

The high voltage is generated by two resonant LC circuits

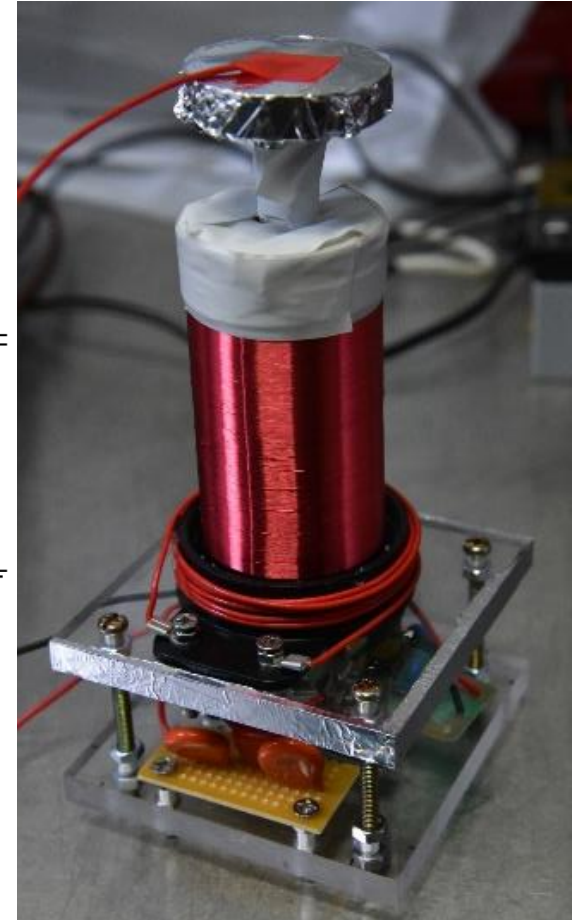
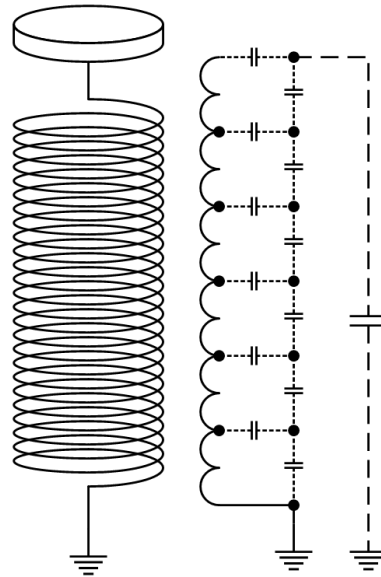
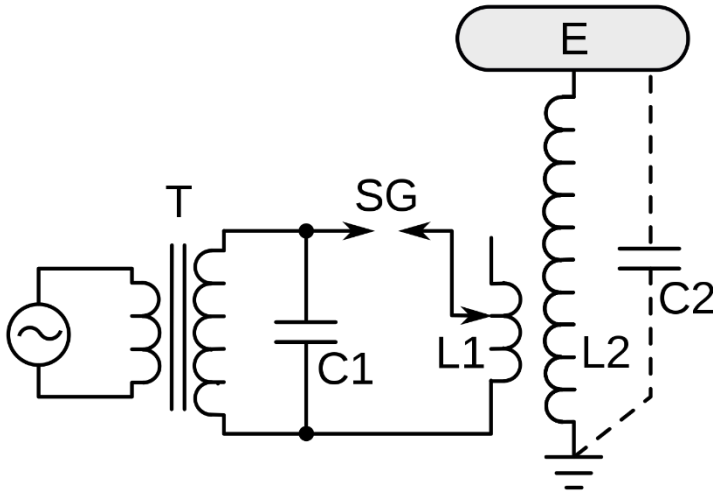

Components of the tesla coil

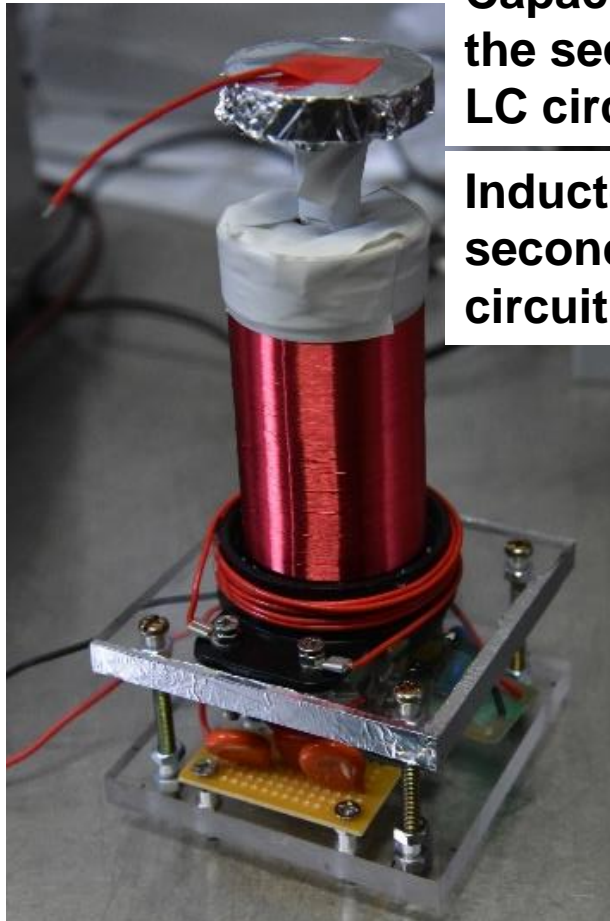

Capacitor of the secondary LC circuit

Inductor of the secondary LC circuit

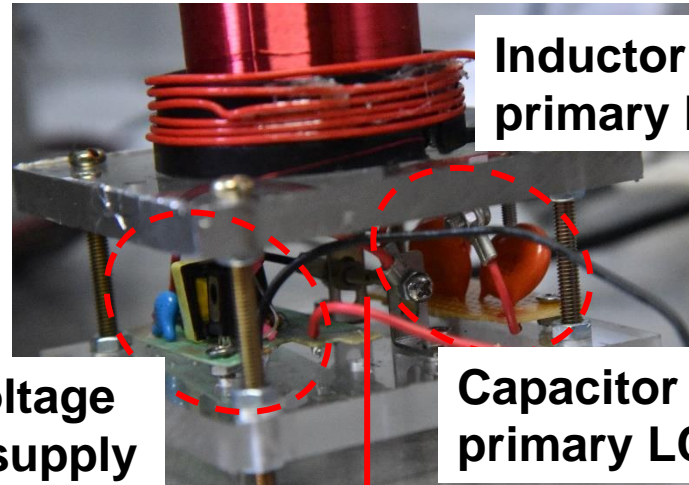

Inductor of the primary LC circuit

High voltage power supply

Capacitor of the primary LC circuit

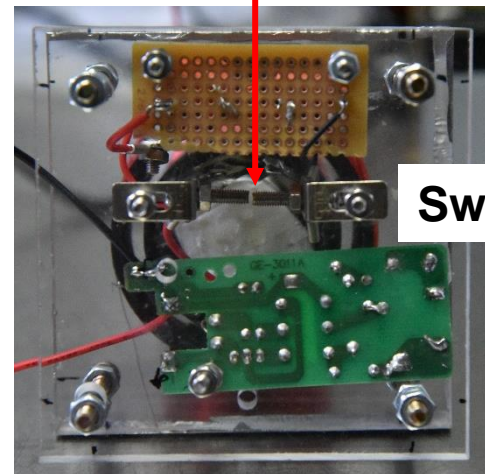

Switch

Show video.

Arc discharge occur between the high voltage and a grounded electrode

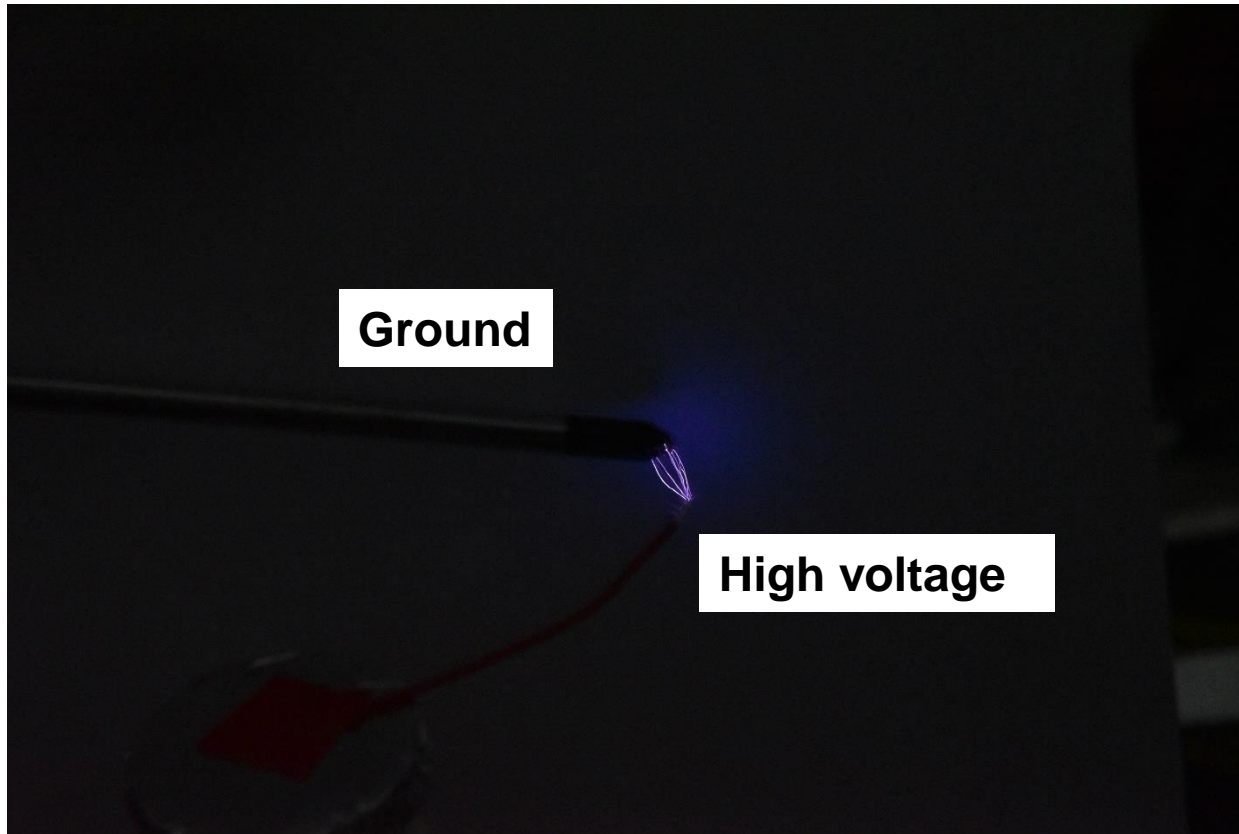

Corona discharge occurs when the electric field drops below a certain value

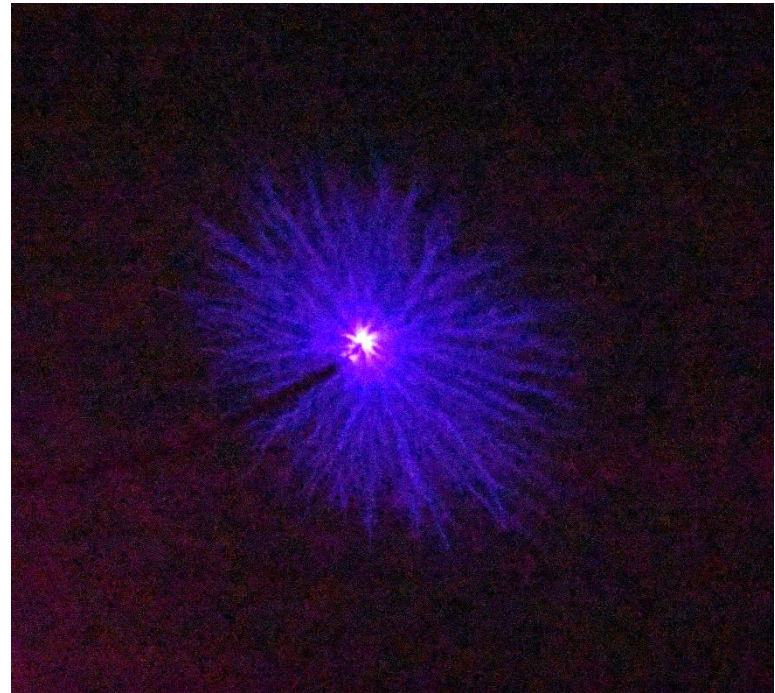
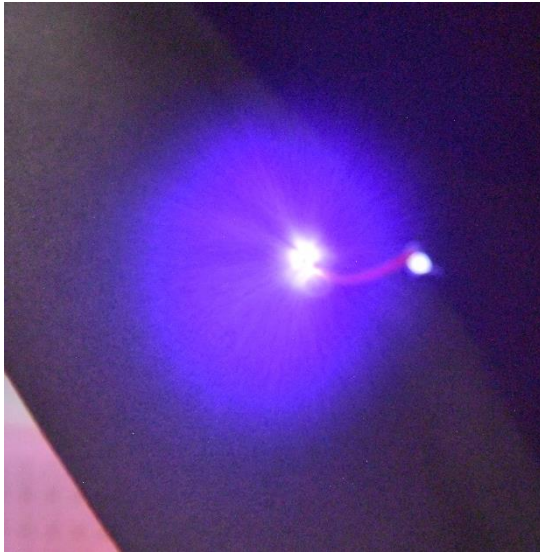

Outlines



- Introduction to pulsed-power system
- Review of circuit analysis
- **Static and dynamic breakdown strength of dielectric materials**
 - Gas – Townsend discharge (avalanche breakdown), Paschen's curve
 - **Liquid**
 - Solid
- Energy storage
 - Pulse discharge capacitors
 - Marx generators
 - Inductive energy storage

Liquids – “all liquid” pulsed-power system is feasible



- **Oil-filled Marx – oil/water filled pulse-forming line (PFL).**
 - oil/water spark gap.
- **Marx: high dielectric strength. (output in the order of 1 MV is generated)**
- **PFL: high dielectric strength, high dielectric constant, low conductivity.**
- **Spark gap: high dielectric strength, high thermal conductivity, minimum decomposition products, self-healing properties.**
- **Properties of liquid needed for high voltage:**
 - **Good thermal properties**
 - **Low viscosity**
 - **Low flammability**
 - **Good chemical and thermal stability**
 - **Works in low temperature**
 - **Environmental considerations**
 - **Low cost**

Shadowgraphy of negative (left column) and positive (right column) streamers in different liquids

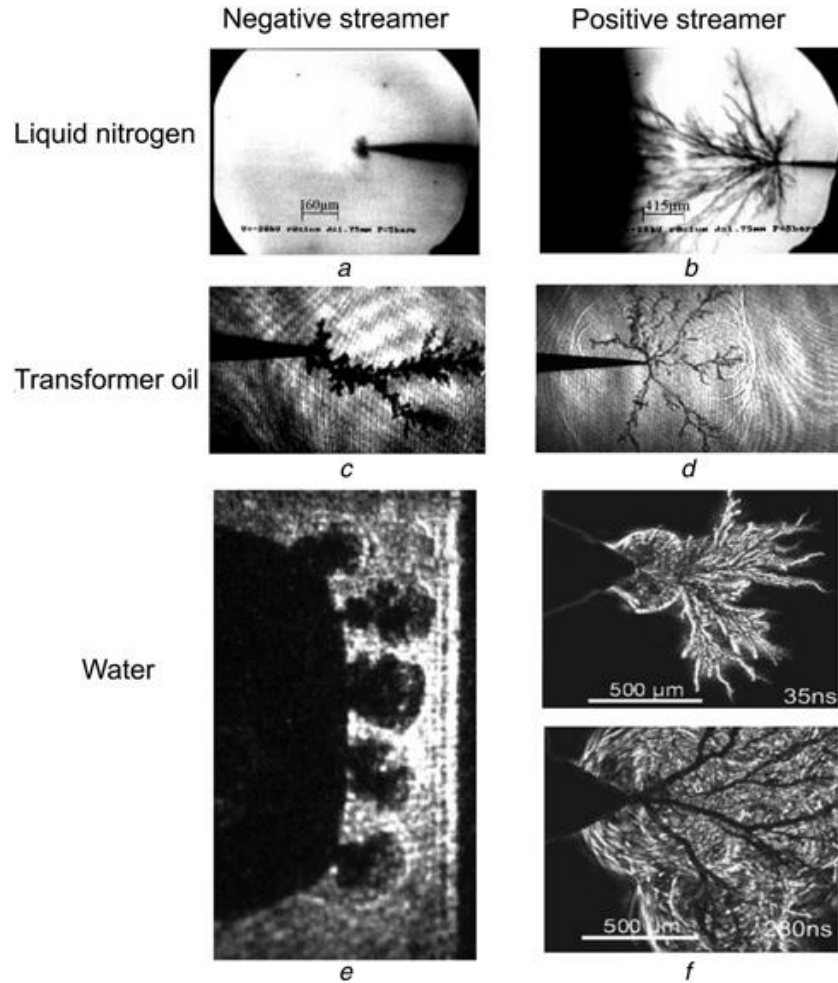

Breakdown in liquid



- **Particle alignment**
- **Electronic breakdown**
- **Streamers in bubbles**

Solid impurities always exist in a liquid leading to breakdown due to particle alignment



- Convection currents are set up in a liquid dielectric due to particle movements even at low applied voltage.
- The force tends to concentrate the solid impurities to the region of the center of the electrodes where the field is fairly uniform.
- Let \vec{F}_D be the diffusion force. If $\vec{F}_\epsilon > \vec{F}_D$, the alignment of the particles takes place along the center of the electrode and breakdown in the liquid takes place along the aligned particles.

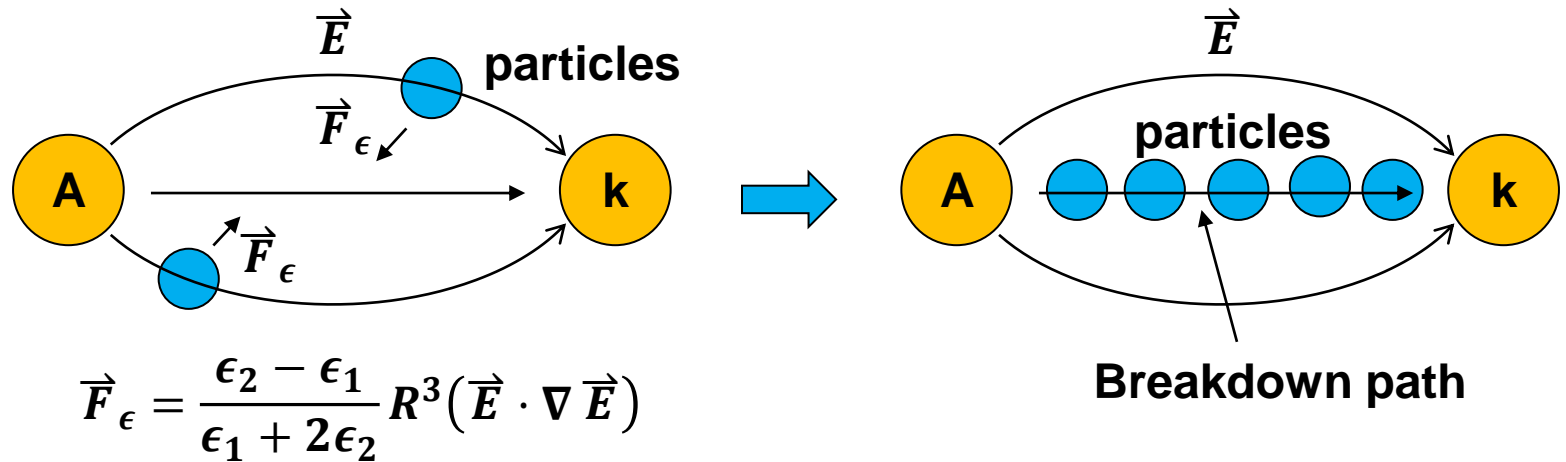

Electronic breakdown is very similar to breakdown in gas

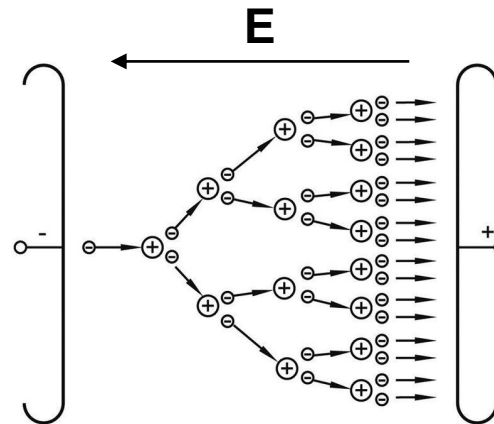

- **Electrons emitted from cathode lose energy to the molecules in the form of “nonionizing collisions” such as elastic, vibration, excitation process.**
- **Normally, not possible for electrons to reach ionization energy.**
- **At elevated temperatures and high field strength near an asperity of an electrode, energy losses reduce.**
 - **continuous acceleration → energy > ionization energy**
 - **more electrons due to impact ionization of the molecule**
 - **avalanche of electrons → breakdown**

Bubbles in liquid are formed so that a breakdown similar to that in gas occurs



- Propagation of streamers in the low-density vapor or bubbles occurs.
- Streamer mechanism of liquid breakdown is similar to the growth of electric stress in a solid due to discharge in a void.
- Discharge in vapor → shockwave & thermal dissipation (heat) → more low-density vapor → more ionization

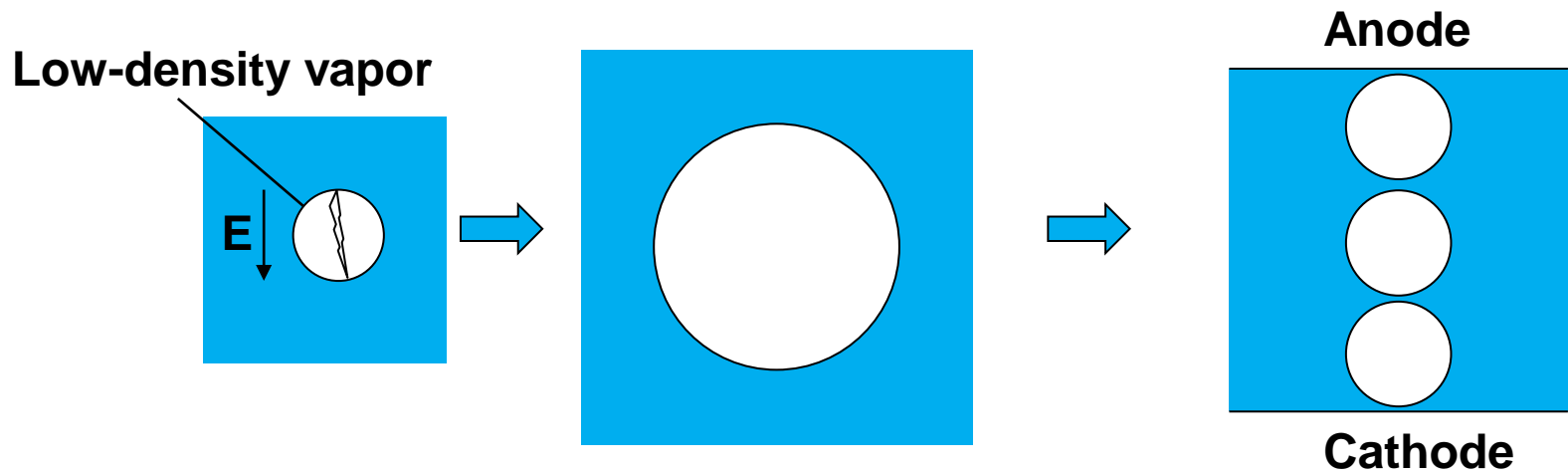

Structures of arcing in liquid is like a tree

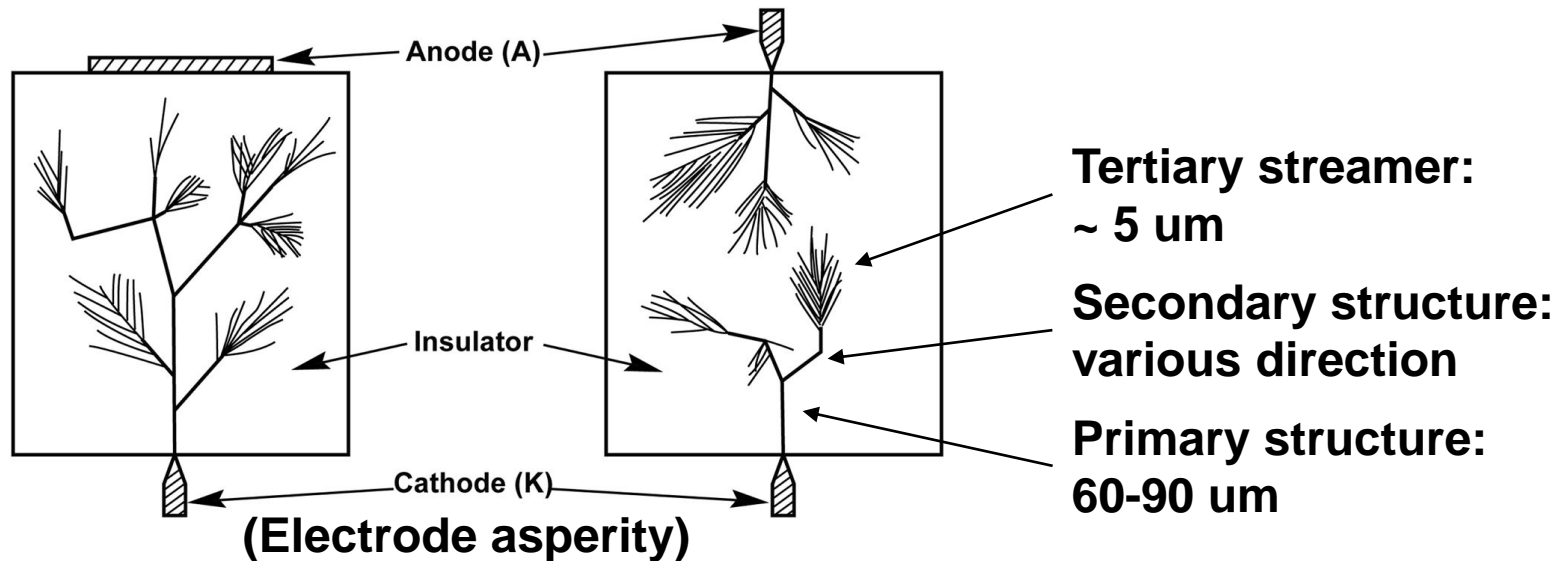

- Secondary and tertiary structures are results of space charge distortion due to the high-density streamer at the front of the primary structure.
- Effect of hydrostatic process:
 - Breakdown voltage increases with higher pressure.
 - Streamer can only grow/be initiated at higher field with higher pressure.
 - Ex: for transformer oil, V_{break} is x3~4 at 4 MPa (~40 Atmosphere).

Mechanisms of bubble formation



- **Foreign particles.**
- **Asperities on electrode causing field emission.**
- **Chemical interaction with molecules causing their dissociation.**
- **Release of the already existing gas dissolved in the liquid.**

Pressure in a bubble is “zero”



- **Krasucki's hypothesis:**

- **A vapor bubble grows continuously when a critical size is reached
→ breakdown takes place.**
- **When applied voltage is gone → collapse faster than air bubble.
→ pressure in the bubble is “zero”.**
- **With impurity particles – bubble grows preferentially on the particles.**
- **W/o impurity particles – bubble grows preferentially near the
electrode surface.**
- **$V_{\text{break}} \uparrow$ as radius of bubble (r_b) \downarrow , surface tension (γ_s) \uparrow , and
hydrostatic pressure (P) \uparrow**

Breakdown tempts to occur easier when the bubble becomes elongated



- Kao's hypothesis – bubble once created starts elongating in the direction of the field keeping its volume remains constant.

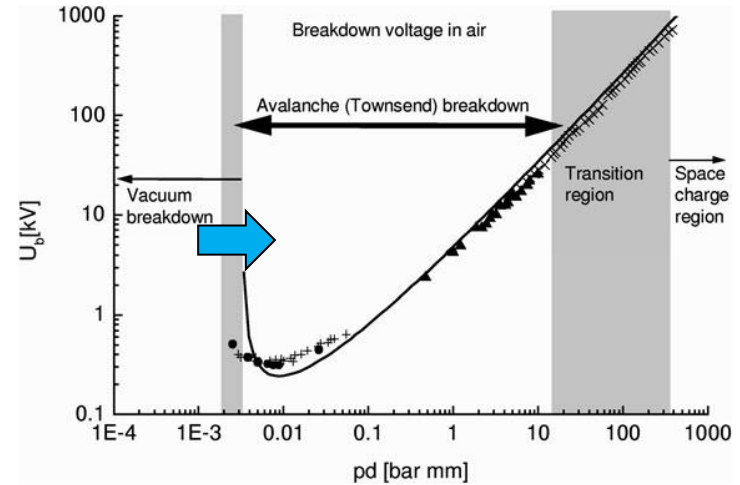
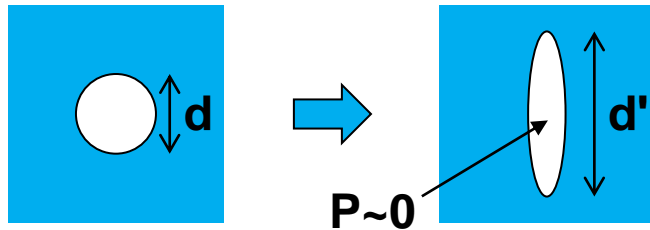

- Sharbaugh and Watson hypothesis

- Asperity of cathode → field emission occurs → mean free path is short → energy is deposited in small region → low-density vapor is generated → breakdown in the bubble.
- For a pulse with few us, enough energy from field emission to vaporize a small mass of liquid ahead of an asperity into a bubble.
- $P \uparrow \Rightarrow$ boiling point $T_b \uparrow \Rightarrow$ more field is required to form bubbles.



Water is a very special dielectric material



- Breakdown voltage is dependent on the polarity.
- Electric field is enhanced at the asperities due to collective orientation of the bipolar water molecules. V_{break} of water ($\epsilon_r=80$) is lower than that of propylene carbonate (PC, $\epsilon_r=65$).
- However,
 - For sub-Mega volt pulse with short duration (7~30 ns), the dielectric strength is x2 of that with long duration (50 ns ~ 1 ms).
 - The $V_{\text{break}} \sim 3 \times 10^7$ V/m for us electric stress.
 - High energy density ($\epsilon_r=80$) in energy storage. $E_{\text{ene}} = \frac{1}{2} \epsilon_0 \epsilon_r E_f^2$
 - Low impedance in PFL.
 - Self-healing post breakdown.
 - Easy maintenance.
 - Low cost.
 - Ease of disposal.

Methods of improving liquid dielectric performance



- **New composition:**
 - **Vegetable oil (used in PFL): castor oil (蓖麻油, $\epsilon_r=4.7$) vs mineral oil (礦物油, $\epsilon_r=2.4$). However, castor oil is more hygroscopic (吸濕性). Therefore, sealing is important.**
 - **Synthetic oil (合成油), e.g., PAO (poly-alpha-olefin), a type of silicone oil. Good for closing switches.**
 - **Resistance to oxidation.**
 - **Lower viscosity, ok at low temperature.**
 - **Good lubrication, ok with hydraulic pump. The pump is used for forced flow at high pressure and velocity for removing gases evolved by molecular dissociation and erosion from electrodes.**
 - **Electron scavengers, e.g., chlorocyclohexane vs cyclohexane**

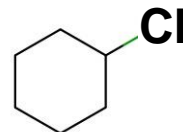

Methods of improving liquid dielectric performance



- **Mixture of materials improve performances**
 - **Gas: SF₆ + N₂**
 - **Liquid: in PFL, Water ($\epsilon_r=80$) + ethylene glycol ($\epsilon_r=44$)**
 - increasing intrinsic time constant.
 - **Solid: paper + polypropylene**
- **Impregnation: when putting insulating films and metallic foils in liquid dielectric for removing of air trapped at electrode-liquid interface :**
 - **High temperature**
 - **Vacuum**
- **Purification**
 - **Freed of foreign particles using filter and ions using deionizer.**
 - **Low temperature using chiller unit to reduce resistance.**

Breakdown in solid

- **Solid insulators function as**
 - Mechanical supports.
 - Enclosures.
 - Feedthrough.
 - Energy storage.

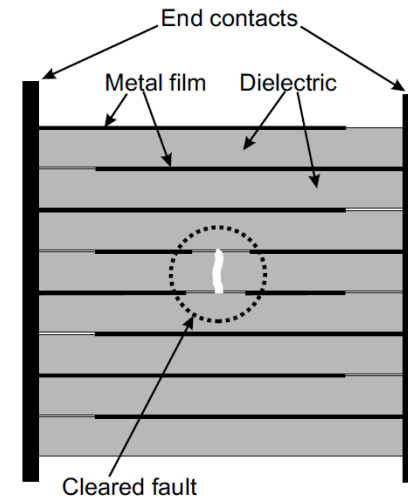

- **Thin films of solid insulation are used in energy storage capacitors and pulse-forming line (PFLs) for high density storage. Advances in metalized films with their self-healing properties are revolutionary.**
- **Common solid film insulators: paper, Mylar (polyethylene terephthalate, PET), Kapton (polyimide), Teflon, Epoxy, polypropylene (PP), Acrylic, Polyvinylidene fluoride (PVDF)**
- **Outdoor installations: operate in humid and polluted environment.**
- **For repetitive pulsed power systems, thermal considerations such as effective cooling becomes important.**

Breakdown mechanisms in solids



- **Solids are usually permanently damaged when breakdown occurs.**
 - **Intrinsic breakdown.**
 - **Thermal breakdown.**
 - **Electromechanical breakdown.**
 - **Partial discharges.**
 - **Electrical trees.**



The highest breakdown values when other sources of imperfections in the materials and testing are eliminated



- The timescale of the intrinsic breakdown is in the order of 10 ns.
- Electrons jump from valence band to conduction band when it gains enough energy from a high electric field.

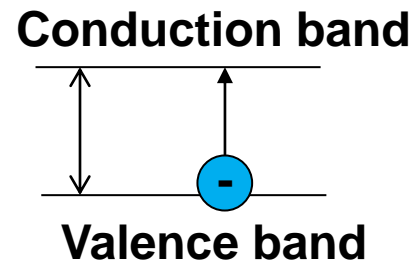

- With sufficient electrons in the conduction band, intrinsic breakdown occurs.
- V_{break} is in the range of 5-10 MV/cm.

In laboratory, it is measured via eliminating all imperfections



- Field non uniformity.
- Internal discharges from imperfections (foreign particles or voids).
- External discharges from weak ambient surrounding the solid dielectric.
- Mechanical damage.
- Field induced chemical attacks.

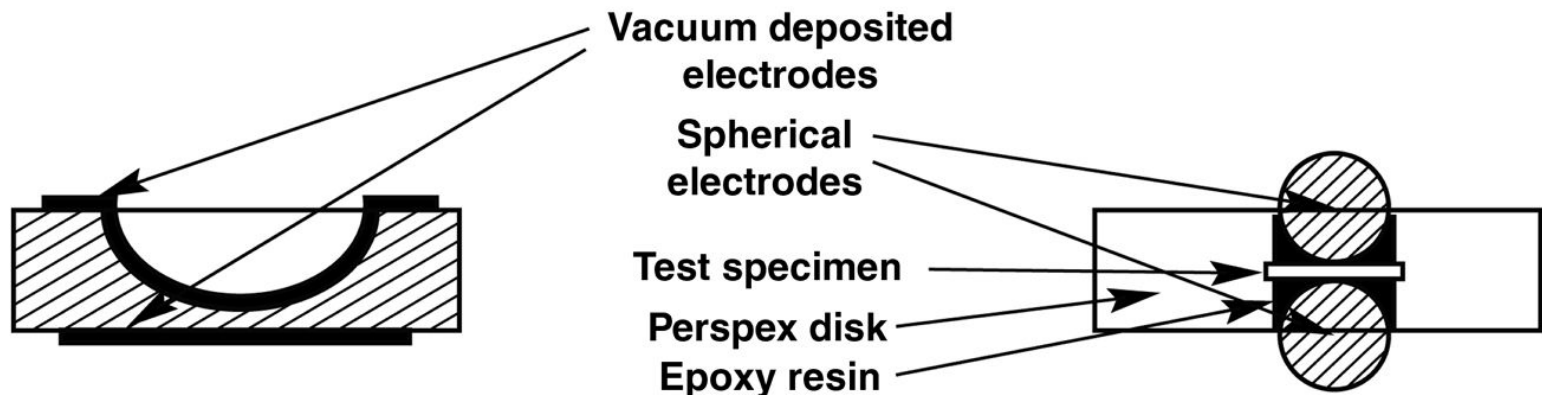

In laboratory, it is measured via eliminating all imperfections



- Very thin specimens of solid dielectric are used.
 - Reasonable V ($E=V/d$).
 - Probability of imperfections (foreign particles and void)
- Proper mechanical support is needed to avoid electromechanical force.
- Short duration pulses with high voltage rising speed → to avoid other breakdown mechanism, such as thermal breakdown from joule heating.

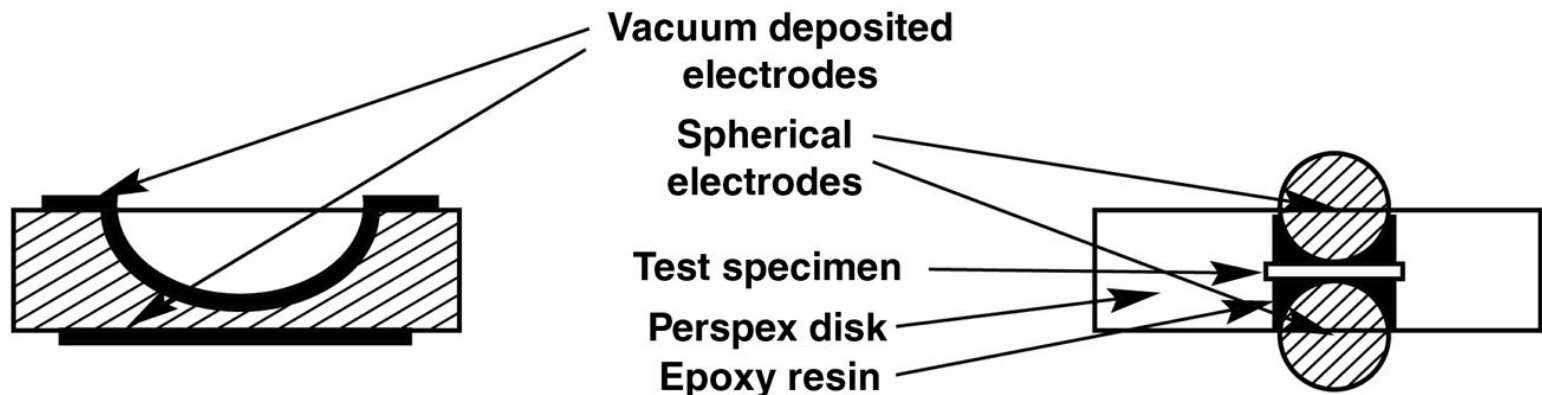

Criterion of intrinsic breakdown of a solid



- **Frohlich criterion (high-energy criterion):**
 - If the net energy gained by a conduction electron from the electric field is greater than the energy lost to the lattice, the electron is continuously accelerated, resulting in a state of instability and intrinsic breakdown occurs.
 - Is not dependent on the specimen thickness, wave front, or duration of applied field.
- **Avalanche criterion (low-energy criterion):**
 - Conduction electrons gain sufficient energy from the applied field to release further electrons from the lattice, similar to impact ionization in gas.
 - It is dependent of thickness and electrode geometry. “Time to breakdown” is dependent on the overvoltage applied to the specimen.

It happens when rate of generating heat is greater than dissipate rate to the surrounding



- Generated heat is due to conduction (DC) or dielectric losses (AC). It is dependent on voltage.
- If heat gain > losses → thermal equilibrium is unstable → thermal runaway.

$$\text{– DC:} \quad HG_{\text{DC}} = C_v \frac{dT}{dt} + \frac{\partial}{\partial x} \left(\kappa \frac{\partial T}{\partial x} \right) = \sigma E^2$$

$$\text{– AC:} \quad HG_{\text{AC}} = C_v \frac{dT}{dt} + \frac{\partial}{\partial x} \left(\kappa \frac{\partial T}{\partial x} \right) = E^2 2\pi f \epsilon_0 \epsilon_r \tan \delta$$

Heat accumulation diffusion source

- Generally, the thermal breakdown need not be considered for DC due to low electric conductivity of good insulator.
- For pulsed high electric field with high dielectric losses, HG_{AC} is important.

Ex: Thermal breakdown @ room temperature ~ 10 MV/cm. With pulsed-high electric field, ~100 KV/cm, 2 order less!

Breakdown occurs due to the compression from the attraction between electrodes



- Compressive force: $P_c = \frac{1}{2} \epsilon_0 \epsilon_r E^2 = \frac{1}{2} \epsilon_0 \epsilon_r \left(\frac{V}{d}\right)^2$

- Hooke's law $P_H = Y \ln\left(\frac{d_0}{d}\right)$

- Force balanced: $P_c = P_H$

$$\frac{1}{2} \epsilon_0 \epsilon_r \left(\frac{V}{d}\right)^2 = Y \ln\left(\frac{d_0}{d}\right) \quad V^2 = \frac{2Y}{\epsilon_0 \epsilon_r} d^2 \ln\left(\frac{d_0}{d}\right) \quad V = d \sqrt{\frac{2Y}{\epsilon_0 \epsilon_r} \ln\left(\frac{d_0}{d}\right)}$$

- $V \uparrow \Rightarrow d \downarrow$. If exceeds the strength of the material \Rightarrow mechanical damage.

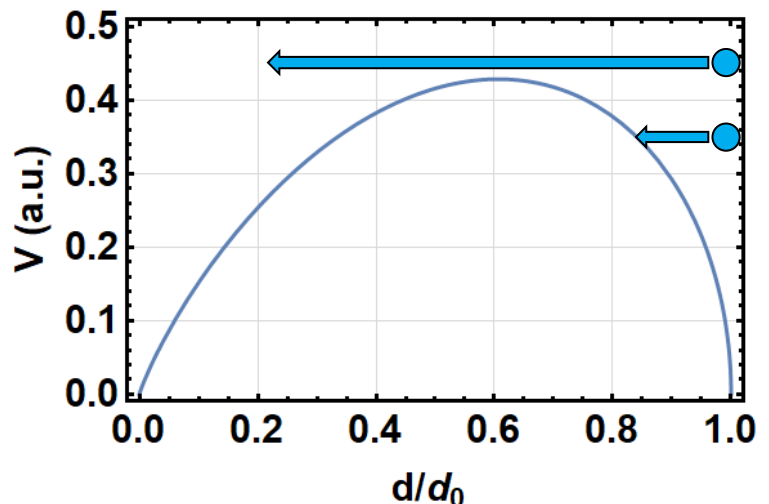
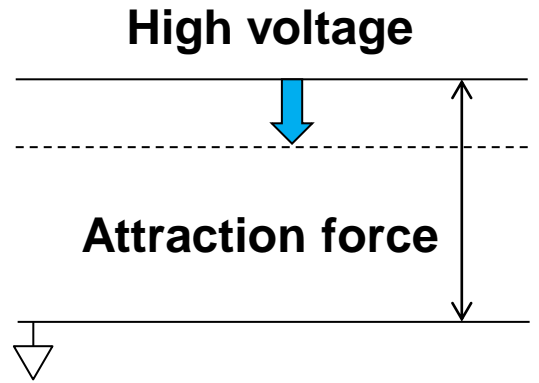

A partial discharge occurs inside voids embedded in solid dielectrics

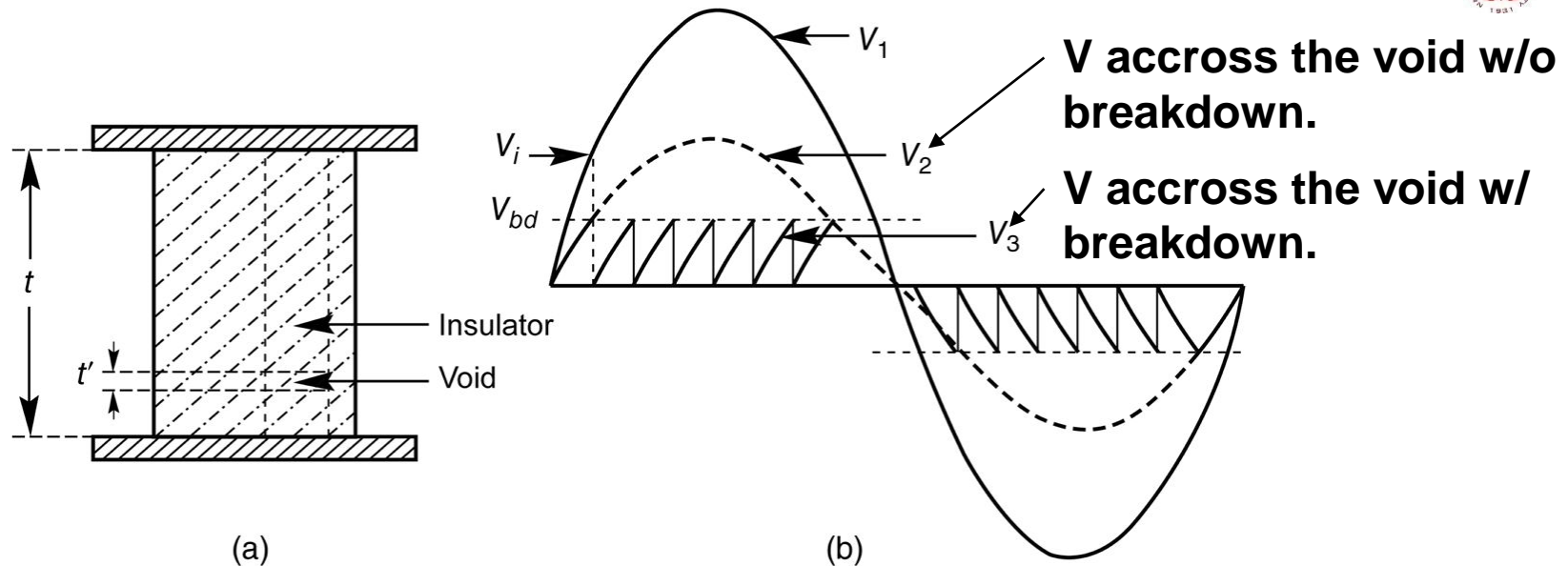

- V_{bd} is determined by the Paschen's curve where $d=t'$, p is pressure in the void.
- The energy dissipated in the void causes erosion, tracking, treeing and electrochemical deterioration.
- It takes a time period of years for causing breakdown through the whole insulator.

There are two kinds of electrical trees: dry trees vs water trees.

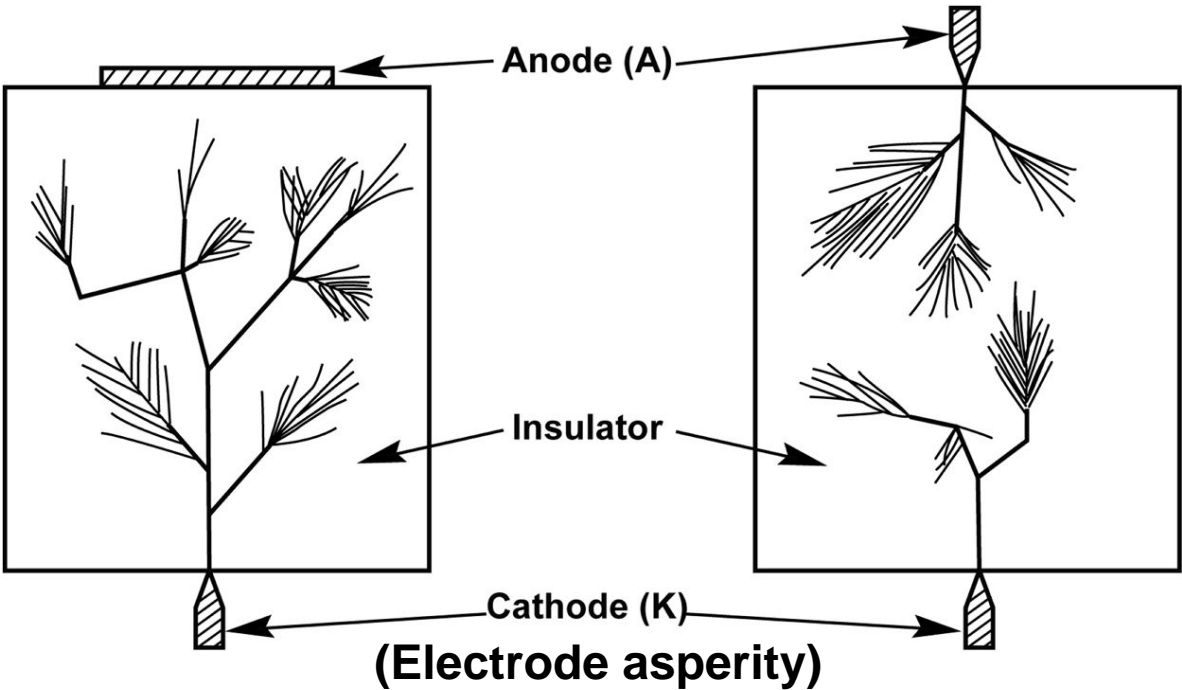

- It is dependent on the properties of dielectric and the environment.
- Over a period of time, may extend to few years, the trees cause the total breakdown.

Dry trees – hollow tubes, resembling the branches of trees, which are formed inside a dielectric due to electrical stress



- Diameter: 10 ~ 500 μm , mixtures of gases from the decomposition of dielectric material.
- Nucleation sites (seed) – localized field enhancements, e.g., asperities on electrodes or embedded foreign particles, or voids.
- Initiation: mostly due to electromechanical force \rightarrow fissures, microscopic cracks.
- Erosion, tracking, gas evolution, decomposed products are produced.
- The accelerated charged particles impact the walls of the cavities w/ high velocities, leading to their growth.
- When a tree occupy a major length of the insulator, the remaining unbridged portion of the insulator will be subjected to extremely high stresses, leading to disruptive breakdown.

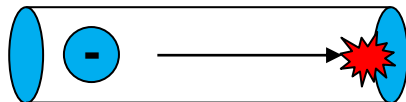

Water trees – hollow filled with water



- If dielectric is hydrophilia (親水) and is immersed in water → tree channels are filled with water. It happens in underground cable.
- When electric stress is removed, water is reabsorbed in the solid dielectric. The channel becomes dry and hollow.
- The electric conductivity of water tress compared to dry trees is high leading to a rapid growth compared to the dry trees.

Methods of improving solid insulator performance



- Layers of insulating films instead of single layer with the same total thickness.
- Improving the contact area at the interface between electrodes and dielectric – metallization and oil impregnation.
- Controlling a nonuniform field – corona guards / equipotential rings.
- Modifying insulator shapes and surface profiles – reduce the interaction of charge carries at the surface.

• Ex:

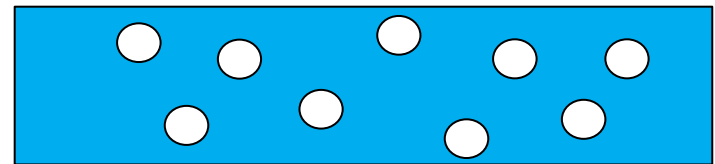
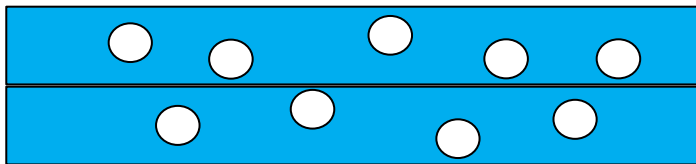

• Ex: insulation in energy storage capacitors

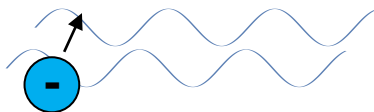

5~7 layers of dielectric films.

Metallization: vapor deposition of Al or Zinc w/ $\delta=0.3$ nm => more layers can be packed leading to higher energy density.

Surge voltage distribution help reducing the chance of breakdown



It can be treated as many capacitors connected in series.

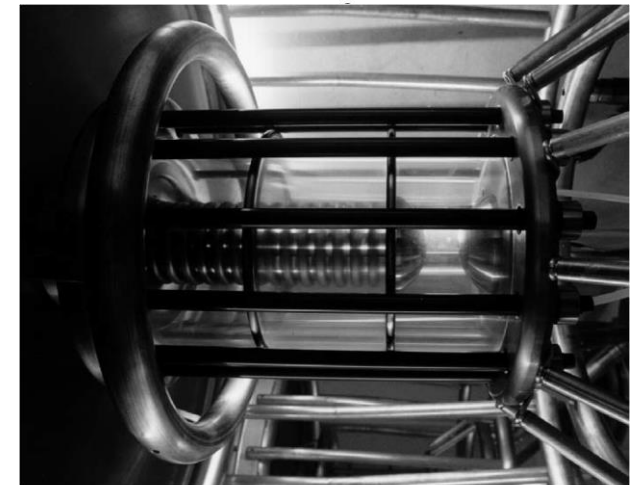
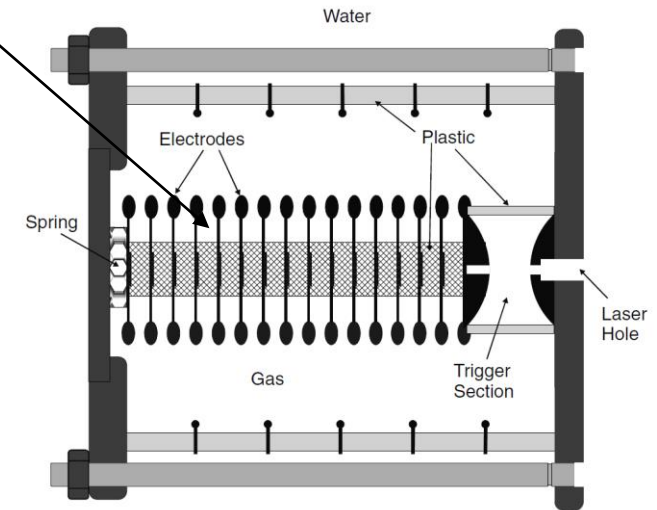
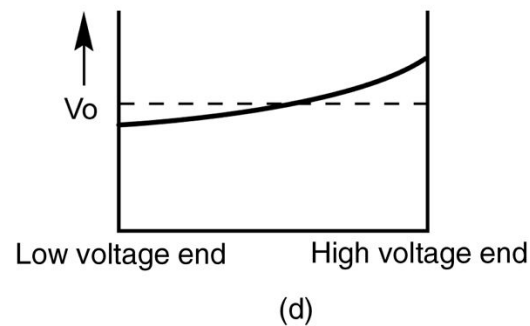
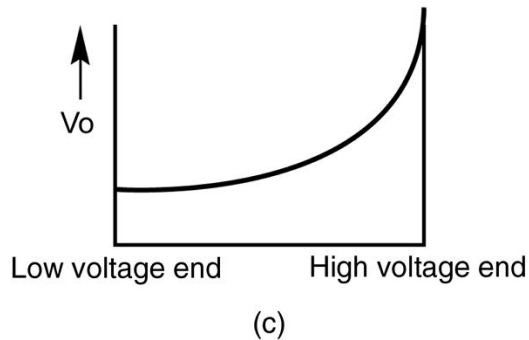
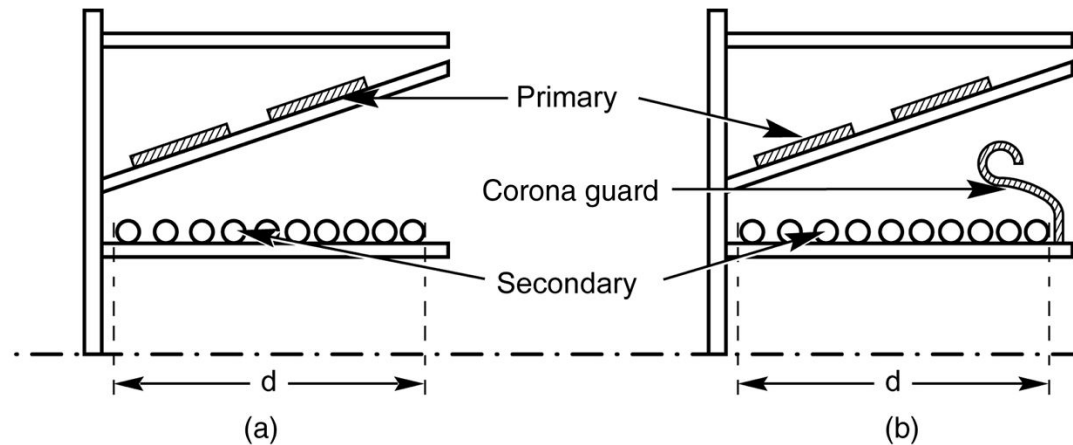
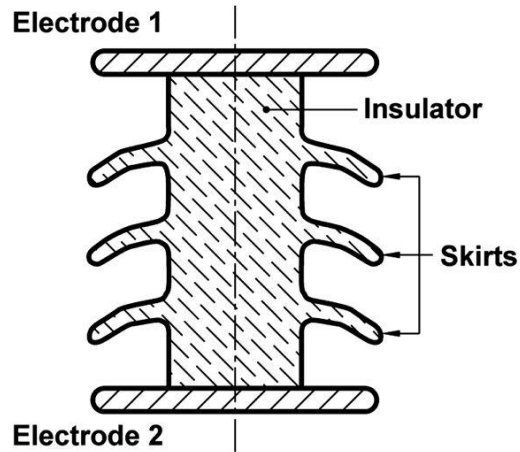
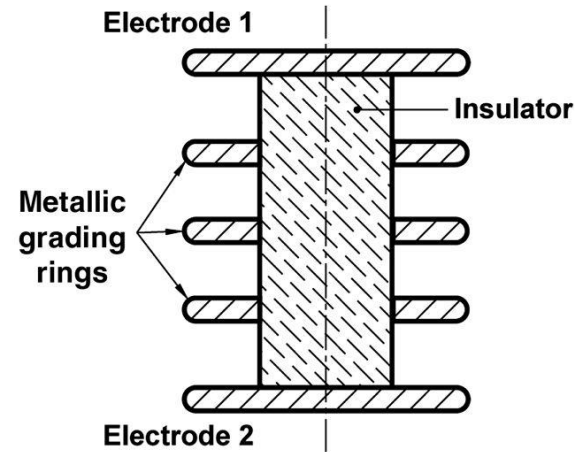

Fig. 4.13. A 4 MV version of a multigap spark switch

Surface flashover in standoff insulators



(a)



(b)

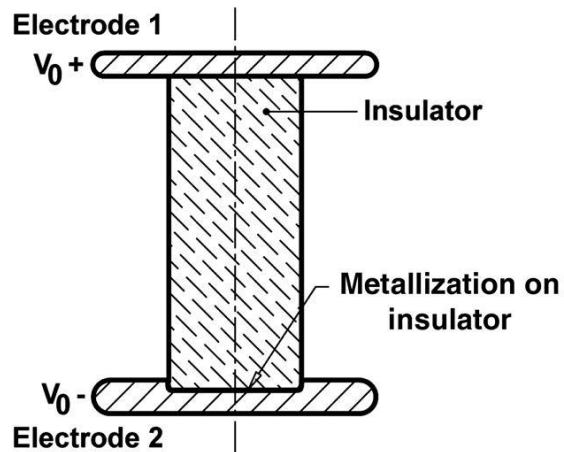

(c)

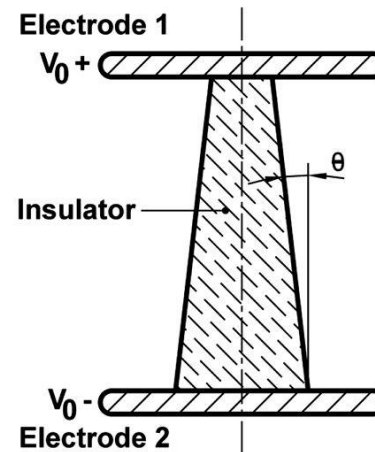

(d)